



Operator Manual

Cummins **Onan**

Performance you rely on.™



Marine Generator Set

MDK BK (Spec A–F)
MDK BL (Spec A–F)
MDK BM (Spec A–F)
MDK BN (Spec A–F)
MDK BP (Spec A–E)
MDK BR (Spec A–E)
MDK BV (Spec A–B)
MDK BT (Spec A–B)
MDK BU (Spec A–B)

California

Proposition 65 Warning

Diesel engine exhaust and some of its constituents are known to the State of California to cause cancer, birth defects, and other reproductive harm.



Table of Contents

SECTION	PAGE
Table of Contents	i
SAFETY PRECAUTIONS	iii
1. INTRODUCTION	1-1
About this Manual	1-1
Model Identification	1-1
How to Obtain Service	1-2
Emissions Label	1-2
noise	1-2
Electromagnetic compatibility	1-3
build standards	1-4
2. CONTROL PANEL	2-1
Remote Control and Monitoring	2-1
Local Control Panel	2-1
Cummins Onan Digital Display Panel	2-3
3. OPERATION	3-1
Fuel Recommendations	3-1
Engine Oil Recommendations	3-1
Engine Coolant	3-2
Batteries	3-2
Fire Extinguisher Port	3-2
Pre-Start Checks	3-3
Priming the Fuel System	3-3
Starting the Generator Set	3-3
Stopping the Generator Set	3-4
Emergency Stop	3-4
Loading the Generator Set	3-4
No-Load Operation	3-5
Resetting Line Circuit Breakers	3-5

Connecting to Shore Power	3-5
Cold Temperature Operation	3-6
Care of New or Re-Built Engine	3-6
Exercising the Generator Set	3-6
Storing the Generator Set	3-6
4. PERIODIC MAINTENANCE	4-1
General Inspection	4-2
Maintaining the Battery and Battery Connections	4-2
Checking Engine Oil Level	4-3
Changing Engine Oil and Filter	4-3
Draining/Replacing Fuel Filters	4-6
Maintaining the Engine Cooling System	4-7
5. TROUBLESHOOTING	5-1
Troubleshooting with Digital Display	5-1
Troubleshooting with Status Lamp	5-1
6. SPECIFICATIONS	6-1
7. MAINTENANCE RECORD	7-1

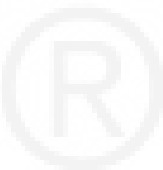

SAFETY PRECAUTIONS

Thoroughly read the OPERATOR MANUAL before operating the generator set. Safe operation and top performance can only be obtained when equipment is operated and maintained properly.

Only trained and experienced service personnel with knowledge of fuels, electricity, and machinery hazards shall remove, dismantle and dispose of the generator set. See service manual.

Some generator set installation procedures present hazards that can result in severe personal injury or death. Only trained and experienced personnel with knowledge of fuels, electricity, and machinery hazards should perform generator set installation procedures.

The following symbols in this manual alert you to potential hazards to the operator, service person and equipment.

⚠ DANGER Used to alert you to a lethal hazard against which you must take steps to prevent severe personal injury or death, as when you are in the vicinity of High Voltage equipment.

⚠ WARNING Used to alert you to a hazard or unsafe practice that can result in severe personal injury or death.

⚠ CAUTION Used to alert you to a hazard or unsafe practice that can result in personal injury or equipment damage.

Electricity, fuel, exhaust, moving parts and batteries present hazards which can result in severe personal injury or death.

ENGINE EXHAUST IS DEADLY

- Never sleep in the boat while the generator set is running unless the boat is equipped with properly working carbon monoxide detectors.
- The exhaust system must be installed in accordance with the generator set Installation Manual and be free of leaks.
- Make sure the bilge is adequately ventilated with a power exhauster.

- Inspect for exhaust leaks every startup and after every eight hours of operation.
- For more information about carbon monoxide see American Boat and Yacht Council (ABYC) publication TH-22—*Educational Information About Carbon Monoxide*.

GENERATOR VOLTAGE IS DEADLY

- Generator electrical output connections must be made by a trained and experienced electrician in accordance with applicable codes.

⚠ WARNING *Interconnecting the generator set and shore power can lead to electrocution of utility line workers, equipment damage and fire. Use an approved switching device to prevent interconnections.*

- Use caution when working on live electrical equipment. Remove jewelry, make sure clothing and shoes are dry, stand on a dry wooden platform or rubber insulating mat and use tools with insulated handles.

DIESEL FUEL IS COMBUSTIBLE

- Do not smoke or turn electrical switches ON or OFF where fuel fumes are present or in areas sharing ventilation with fuel tanks or equipment. Keep flames, sparks, pilot lights, arc-producing equipment and all other sources of ignition well away.
- Fuel lines must be secured, free of leaks and separated or shielded from electrical wiring.

MOVING PARTS CAN CAUSE SEVERE PERSONAL INJURY OR DEATH

- Do not wear loose clothing or jewelry near moving parts such as PTO shafts, fans, belts and pulleys.
- Keep hands away from moving parts.
- Keep guards in place over fans, belts, pulleys, and other moving parts.

BATTERY GAS IS EXPLOSIVE

- Wear splash-proof safety glasses.
- Do not smoke or permit flames or sparks to occur near the battery at any time.

- To reduce arcing when disconnecting or reconnecting battery cables, always disconnect the negative (-) battery cable first and reconnect it last.

FLAMMABLE VAPOR CAN CAUSE A DIESEL ENGINE TO OVERSPEED

⚠️WARNING *Do not operate a diesel-powered generator set where a flammable vapor environment can be created by fuel spill, leak, etc.*

Flammable vapor can cause a diesel engine to overspeed and become difficult to stop, resulting in possible fire, explosion, severe personal injury and death. The owners and operators of the generator set are solely responsible for operating the generator set safely.

GENERAL PRECAUTIONS

- Keep children away from the generator set.
- Do not use evaporative starting fluids. They are highly explosive.
- Do not step on the generator set when entering or leaving the generator room. Parts can bend or break leading to electrical shorts or to fuel, coolant or exhaust leaks.
- To prevent accidental or remote starting while working on the generator set, disconnect the negative (-) battery cable at the battery.
- Let the engine cool down before removing the coolant pressure cap or opening the coolant drain. Hot coolant under pressure can spray and cause severe burns.
- Keep the generator set, drip pan and compartment clean. Oily rags can catch fire. Gear stowed in the compartment can restrict cooling.
- Make sure all fasteners are secure and properly torqued.
- Do not work on the generator set when mentally or physically fatigued or after having consumed alcohol or drugs.
- Used engine oil has been identified by some U. S. state and federal agencies as causing cancer or reproductive toxicity. Do not ingest, inhale, or contact used oil or its vapors.
- Ethylene glycol, used as engine coolant, is toxic to humans and animals. Clean up spills and dispose of used engine coolant in accordance with local environmental regulations.
- Keep multi-purpose fire extinguishers handy. Multi-purpose fire extinguishers are used for fires that involve ordinary combustible materials such as wood and cloth; combustible and flammable liquid fuels and gaseous fuels; live electrical equipment. (North America or US: Ref. NFPA No. 10)
- Generator set installation and operation must comply with all applicable local, state and federal codes and regulations.
- Generator sets with a sound shield shall not be run with the service doors removed/missing.
- Engine components can be hot and cause severe burns. Hot coolant under pressure can spray and cause severe burns.
- Use personal protective equipment when maintaining or installing the generator set such as gloves, safety glasses, etc.

THE HAZARDS OF CARBON MONOXIDE

Engine-driven generators can produce harmful levels of carbon monoxide that can injure or kill you. The nature of boating is such that you can be harmed by this poisonous gas despite good generator set maintenance and proper ventilation.

ONLY YOU CAN PROTECT YOURSELF FROM CO POISONING!

- Watch constantly for swimmers when the generator set is running.
- Make sure exhaust cannot get under the deck, between hulls or enter the living quarters through a window, vent or door.
- Make sure all CO detectors and audible alarms are working properly.
- Pay attention to the signs of CO poisoning.
- Check the exhaust system for corrosion, obstruction and leaks each time you start the generator set and every eight hours if you run it continuously.

SUBSTANCE HAZARDOUS TO HEALTH

Generator sets use substances, and emit and create wastes that can cause health risks. Generator set operators must use appropriate personal protective equipment (such as clothing, gloves, protective glasses/goggles, and respiration equipment) when exposed to fuel, oil, coolant, wet batteries, grease, cleaning agents, or other substances exposed to lungs, eyes, or skin. Use appropriate containers for transport, storage, and disposal of waste substances. Follow local regulations for disposal and recycling.

ANTIFREEZE (FLEETGUARD – ES COMPLEAT/EG PREMIX)

This antifreeze is also known as an ethylene glycol based coolant; summer coolant; coolant additive. It is purple coloured, viscous liquid, with a mild chemical odour, is soluble in water and harmful. It contains ethylene glycol, and diethylene glycol. Ethylene glycol is a potentially hazardous constituent.

The substance has a boiling point of 107° C, and a flash point of 121° C.

It is used as an engine coolant additive, and can be found in engine cooling systems, and heat exchangers. Installers, operators and maintainers are likely to encounter this substance.

HAZARDOUS REACTIONS

Ethylene glycol is combustible when exposed to heat or flame and can react vigorously with oxidants. Moderate explosive hazard in form of vapour when exposed to heat or flame. Hazardous products resulting from combustion or decomposition include carbon monoxide, carbon dioxide and acrid smoke. Self-contained breathing apparatus must be worn in the event of fume build up.

Avoid strong oxidizing agents – incompatible with sulfuric acid, nitric acid, caustics and aliphatic amines.

It may cause neurological signs and symptoms, and kidney damage. It is also a skin and eye irritant.

Very toxic in particulate form upon inhalation. Harmful if swallowed, lethal dose for humans reported to be 100ml.

PROTECTIVE MEASURES

Refrain from eating, drinking or smoking when using the product. Adopt a high standard of personal hygiene. In case of skin contact, wash immediately with soap and water.

Ensure good ventilation and avoid heat sources. Avoid breathing mist, if there is a risk of vapour, or particulate, use a suitable organic vapour mask.

Eye protection, gloves, overalls, impervious apron should be used. Avoid contamination inside the gloves. If overalls become contaminated, discontinue use and clean thoroughly.

STORAGE/TRANSPORT

Store and transport only in correctly marked containers. Keep containers closed when not in use. Keep cool, out of sunlight, away from naked flames and strong acids, do not freeze. Store well away from food-stuffs and drinking water. Take special care to avoid discharge into drains, sewers and water-courses.

Contain leak/spill with sand, earth or non-combustible, absorbent material to prevent entry of substance into drainage/sewerage system, water-courses and land. Eliminate all ignition sources, use plastic shovel to transfer to suitable container and dispose of unwanted or absorbed substance through an authorised contractor to a licensed site.

EMERGENCY ACTION

- Fire
Extinguishing media: CO₂, alcohol resistant foam, dry powder, or water spray.
Fire fighters to use self contained breathing apparatus. Keep fire exposed containers cool. Prevent run-off from entering waterways, drains and drinking water supplies.
- Ingestion
Toxic by ingestion. If swallowed induce vomiting only under the advice of a Doctor or poison control centre. Delayed treatment may result in fatality.
- Inhalation (of vapour)
Remove from further exposure. In case of irritation to lungs or throat, seek medical advice.
- Aspiration (inhalation of liquid)
Obtain immediate medical assistance.
- Eyes
Flush copiously with water or preferably eye-

wash solution for at least five minutes. Seek medical advice.

- Skin
Wash thoroughly with soap and water, and seek medical attention if irritation develops. Change clothing if necessary and wash before re-use.
- Spillage
Soak-up using an absorbent material and dispose of this as directed under Storage/Transport.

GAS OIL

This product is also known as Red Diesel, Fuel Oil, and type A1 or A2. It can be pale red or a clear liquid with a characteristic mild odour. It contains catalytically cracked oil, petroleum distillates, quinizarin, and gas oil maker dye red. The catalytically cracked oil and petroleum distillates are potentially hazardous constituents.

The substance has an initial boiling point of 180°C, a flash point greater than 56°C, and a vapour pressure less than 0.7mm Hg at 20°C and has negligible solubility in water.

It is used as a fuel for off-road diesel powered vehicles and stationary engines, and can be found in fuel tanks, pipes and injection systems. The substance should not be used for any other purpose without contacting the manufacturer or supplier. Installers, operators and maintainers are likely to encounter this substance.

HAZARDOUS REACTIONS

This liquid is flammable. Avoid smoking, heat sources, such as welding and naked flames, sparks and static electricity build-up. Thermal decomposition products are hazardous, containing CO_x, NO_x and SO_x compounds.

The vapour is explosive. High vapour concentrations can cause respiratory irritation, dizziness, nausea, and loss of consciousness. Excessive and prolonged exposure to the mist can cause chronic inflammatory reaction of the lungs and a form of pulmonary fibrosis.

Avoid strong oxidising agents, e.g. chlorates which may be used in agriculture.

Gas oil is slightly irritating to the skin and has a de-fatting action. Toxicity following single exposure to

high level of gas oil is of low order. Prolonged, repeated skin contact may de-fat the skin resulting in possible skin irritation and dermatitis. In some cases warty, cancerous growths have occurred.

PROTECTIVE MEASURES

Ensure good ventilation and avoid heat sources. Observance of good housekeeping rules will ensure general safety. Do not smoke. Avoid breathing mist.

When working on, or testing, injection equipment, special care is required to avoid perforation of skin by high pressure fuel. Use eye protection in the event of suspected high pressure leak.

Adopt a high standard of personal hygiene. In the case of skin contact, wash well with soap and water.

Use glove and overalls, and eye protection goggles if there is a risk of splashing. Use oil impervious gloves and avoid contamination inside the gloves. If overalls become contaminated, discontinue use and clean thoroughly. Contaminated clothing should be removed, soaked with water, and laundered before re-use.

No special respiratory precautions are necessary in normal use.

DO NOT use as a solvent for removing dirt/grease etc, from skin.

STORAGE/TRANSPORT

Store and transport only in correctly marked containers. Keep containers closed when not in use. Keep cool, out of sunlight and away from naked flames. Electrical continuity is required between the transport and storage vessels during product transfer.

Contain leak/spill with sand, earth or other suitable material, and prevent entry of substance into drainage/sewerage system, water-courses and land. Dispose of unwanted or absorbed substance through an authorised contractor to a licensed site.

Inform local and fire authorities should the product reach waterways, drains etc.

EMERGENCY ACTION

- Fire
Extinguishing media:
Large fire – Foam/water fog. Never use water jet.

Small fire – foam/dry powder, AAAF, CO₂, sand, earth.

Avoid making sparks. Fire fighters to use self-contained breathing apparatus. Keep fire exposed containers cool, using water fog/spray. Prevent run-off from entering waterway, drains and drinking water supplies.

- Ingestion
Do not induce vomiting. Wash the mouth out with water, and send to hospital immediately.
- Inhalation (of vapour)
Remove from further exposure. Obtain medical assistance immediately.
- Aspiration (inhalation of liquid)
If, following ingestion of gas oil, vomiting occurs, there is danger of aspiration into the lungs. This would cause intense local irritation and chemical pneumonitis that can be fatal. Obtain immediate medical assistance.
- Eyes
Irrigate copiously with water or preferably eye-wash solution for at least five minutes. If irritation persists seek medical advice.
- Skin
Wash thoroughly with soap and water. Change clothing if necessary.
If high pressure injection has occurred prompt surgical attention is required.
- Spillage
Absorb using sand, earth or other suitable material. Dispose of unwanted or absorbed flammable material as directed under Storage/Transport.

LUBRICATION OIL – PREMIUM BLUE E 15W40

Also known as oil, lube oil, sump oil, new oil is dark, viscous liquid with a slight, characteristic odour. The base oil contains: distillates (petroleum), solvent-dewaxed heavy paraffinic. It is not classified as dangerous according to Directive 1999/45/EC and its amendments, and is not classified according to the EU regulations.

It has a boiling point greater than 150°C, a flash point Open Cup of 220°C (Cleveland), and is insoluble in cold water.

It is used in engine lubricant oil systems, sump pan and filters, make-up tanks and piping systems as a

lubrication oil for use in wide range of diesel engines operating under severe conditions. Installers, operators and maintainers are likely to encounter this product.

HAZARDOUS REACTIONS

This product is stable although slightly re-active with oxidising agents. Results of decomposition are carbon oxides (CO, CO₂) and water.

Although harmful if swallowed or aspirated (breathed in), repeated or prolonged exposure is not known to aggravate medical conditions.

Used oil may contain harmful combustion by-products and unburnt fuel that will cause skin reactions as detailed for fuel. Particular care must be taken if oil from a severely overheated engine is handled – use impervious gloves, lab coat and safety glasses.

Do not breathe vapour/spray.

PROTECTIVE MEASURES

Ensure good ventilation and avoid heat sources.

Adopt a high standard of personal hygiene. In case of skin contact, wash thoroughly with soap and water.

Use safety glasses, impervious gloves and lab coat. Avoid contamination inside the gloves. If overalls become contaminated, discontinue use and clean thoroughly.

No special respiratory precautions are necessary in normal use. Do not breathe vapour/spray when handling hot materials.

STORAGE/TRANSPORT

Store and transport only in correctly marked containers. Keep containers tightly sealed when not in use. Keep in a cool, well ventilated area, out of sunlight and away from naked flames. Store well away from food-stuffs and drinking water.

Wear splash goggles, full suit, boots and gloves. Absorb leak/spill with an inert material and dispose of unwanted or absorbed substance through an authorised contractor to a licensed site. Finish cleaning by spreading water on the contaminated surface and allow to evacuate through the sanitary system.











EMERGENCY ACTION

- Fire
Extinguishing media:
Large fire – Use water spray, fog or foam. Do not use water jet.
Small fire – Use dry chemical powder or CO₂
Fire-fighters to use self contained breathing apparatus and full turnout gear. Keep fire exposed containers cool.
- Ingestion
Do not induce vomiting, Obtain medical advice immediately.
- Inhalation (of vapour)
Remove from further exposure. Obtain medical attention.
- Aspiration (inhalation of liquid)
Obtain immediate medical assistance
- Eyes
Flush copiously with water or preferably eye-wash solution for at least fifteen minutes. Obtain medical advice.
- Skin
Wash thoroughly with soap and water. Obtain medical advice if irritation develops. Change clothing if necessary and wash before re-use.
- Spillage
Absorb with an inert material and dispose of this as directed under Storage/Transport.



Generator Set Warning Labels

Warning signs are provided on the generator set at or near the point of risk. To avoid injury, always take the necessary precautions – as indicated on the sample signs shown below:

	Caution / Warning. Indicates a risk of personal injury.
	Caution / Warning of Temperature Hazard. Indicates a risk of personal injury from high temperature.
	Caution / Warning of High Voltage Hazard. Indicates a risk of personal injury from electric shock/electrocution.
	Caution / Warning of Engine Coolant Pressure Hazard. Indicates a risk of personal injury from hot pressurized engine coolant.
	Caution / Warning. Indicates to read Operator manual for additional information.
	Caution / Warning of No Step. Indicates a risk of personal injury or equipment damage from stepping on equipment.
	Caution / Warning of Combustion/Explosion Hazard. Indicates a risk of personal injury from explosion.
	Caution / Warning of Belt and Rotating Part Hazard. Indicates a risk of personal injury from entanglement in moving parts.
	Caution / Warning of Chemical (ingestion/burn) Hazard. Indicates a risk of personal injury or asphyxiation from poisonous fumes or toxic gases.
	Caution / Warning of High Voltage or Current Source Hazard. Indicates a risk of personal injury from electrical shock/electrocution.

1. Introduction

ABOUT THIS MANUAL

This is the Operator Manual for the generator sets listed on the front cover. Each operator should study this manual carefully and observe all of its instructions and safety precautions. Keep this manual close at hand for reference.

⚠WARNING *This generator set is not a life support system. It can stop without warning. Children, persons with physical or mental limitations, and pets could suffer personal injury or death. A personal attendant, redundant power or alarm system must be used if generator set operation is critical.*

⚠WARNING *This generator set is not “ignition protected” and shall not be used in flammable vapor environment.*

⚠WARNING *This generator set shall not be the main source of power for communication and steering systems. It can stop without warning.*

Operation, Periodic Maintenance and Troubleshooting provide the instructions necessary for operating the generator set and maintaining it at top performance. The owner is responsible for performing maintenance in accordance with the PERIODIC MAINTENANCE SCHEDULE (p. 4-1). This manual also includes generator set specifications, information on how to obtain service, and information regarding compliance with emissions regulations.

See the Parts Manual for part identification numbers and required quantities. Genuine Cummins Onan replacement parts are recommended for best results.

⚠WARNING *Within the Parts Manual, MC parts are MACHINE CRITICAL and must comply with boating safety ignition protection, backfire, fire resistance, exhaust system integrity, or other requirements established by regulatory agencies, such as the US Coast Guard, ABYC, and ISO. When MACHINE CRITICAL parts are replaced for any reason, use Onan parts that are identified with the part numbers in the appropriate Parts Manual.*

MODEL IDENTIFICATION

Be ready to provide the generator set model and serial numbers on the nameplate when contacting Cummins Onan for parts, service and product information. Figure 1-1 illustrates the nameplate and its location on the side of the control box. Every character in these numbers is significant. (The last character of the model number is the specification letter, which is important for obtaining the right parts.) Record the generator set model and serial numbers on the lines designated in the figure so that they are easy to find when you need them.

⚠WARNING *Improper service or replacement of parts can lead to severe personal injury or death and to damage to equipment and property. Service personnel must be qualified to perform electrical and mechanical service.*

IMPORTANT ENGINE INFORMATION
CUMMINS POWER GENERATION
1400 73rd Ave. NE
Minneapolis, MN 55432

Model: _____ Spec: Made in U.S.A.
S/N: _____ KVA Pf KW PH RPM
50 Hz: _____
60 Hz: _____

As Manufactured:
Freq: _____ AC Volts: _____ Amps: _____

Options: _____ Fuel: _____ Bat: _____
Software Cfg: _____
Wire Diagram: _____

Insulation - NEMA Class Ambient 40°C

REFER TO OPERATOR'S MANUAL FOR MAINTENANCE SPECIFICATIONS AND ADJUSTMENTS.

99-2495

MODEL NUMBER: _____
SERIAL NUMBER: _____

FIGURE 1-1. TYPICAL NAMEPLATE

HOW TO OBTAIN SERVICE

For generator set parts, service, and product information (such as the Service Manual), contact the nearest authorized Cummins Onan distributor. You may go to Internet site www.cumminsonan.com for information for contacting our distributors worldwide.

In North America

Call 1-800-888-6626 for the nearest Cummins Onan distributor in the United States or Canada. Press 1 (OPTION 1) to be automatically connected.

If you are unable to contact a distributor using the automated service, consult the Yellow Pages. Typically, our distributors are listed under:

GENERATORS – ELECTRIC

Outside North America

Call Cummins Power Generation at 1-763-574-5000 from 7:30 AM to 4:00 PM (Central Standard Time), Monday through Friday, or fax 1-763-528-7229.

Information To Have Available

1. *Model Number, including Spec Letter, and Serial Number (Figure 1-1).*
2. *Date of purchase.*
3. *Nature of problem (Section 5. Troubleshooting).*

EMISSIONS LABEL

The label that states compliance with applicable engine emissions regulations is located on the engine as circled in Figure 1-2. Refer also to the FEDERAL EMISSION DESIGN AND DEFECT LIMITED WARRANTY FOR C. I. ENGINES (DIESELS) that was shipped in the same package as the Operator's Manual.

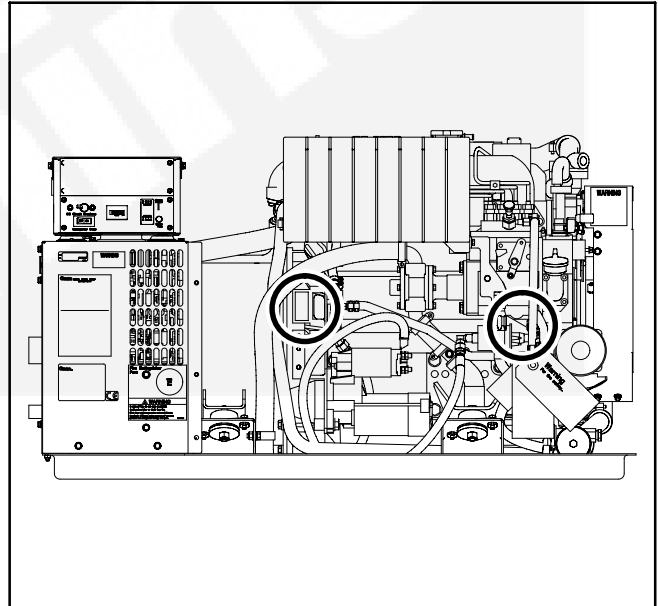

FIGURE 1-2. TYPICAL EMISSIONS LABEL LOCATIONS

NOISE

Generator sets emit noise. As noise level and time of exposure increase, risk of hearing damage increases. The Specifications page in the Operator manual states noise level for this generator set. Select and use personal hearing protection appropriate for your exposure to generator set noise.

Note for use in countries where compliance to the EU Noise directive is required: This generator set has not been evaluated and is not marked for use in open air. Install the generator set in accordance with the Installation manual. Obey local noise restrictions when you operate the generator set.

ELECTROMAGNETIC COMPATIBILITY

Generator sets emit and receive electromagnetic (radio frequency) energy. If the generator set affects operation of nearby devices, or nearby devices affect generator set operation, increase the distance between them.

Note for use in countries where compliance to the EMC directive is required: This generator set has been evaluated for use in residential, commercial, and light industrial environments.

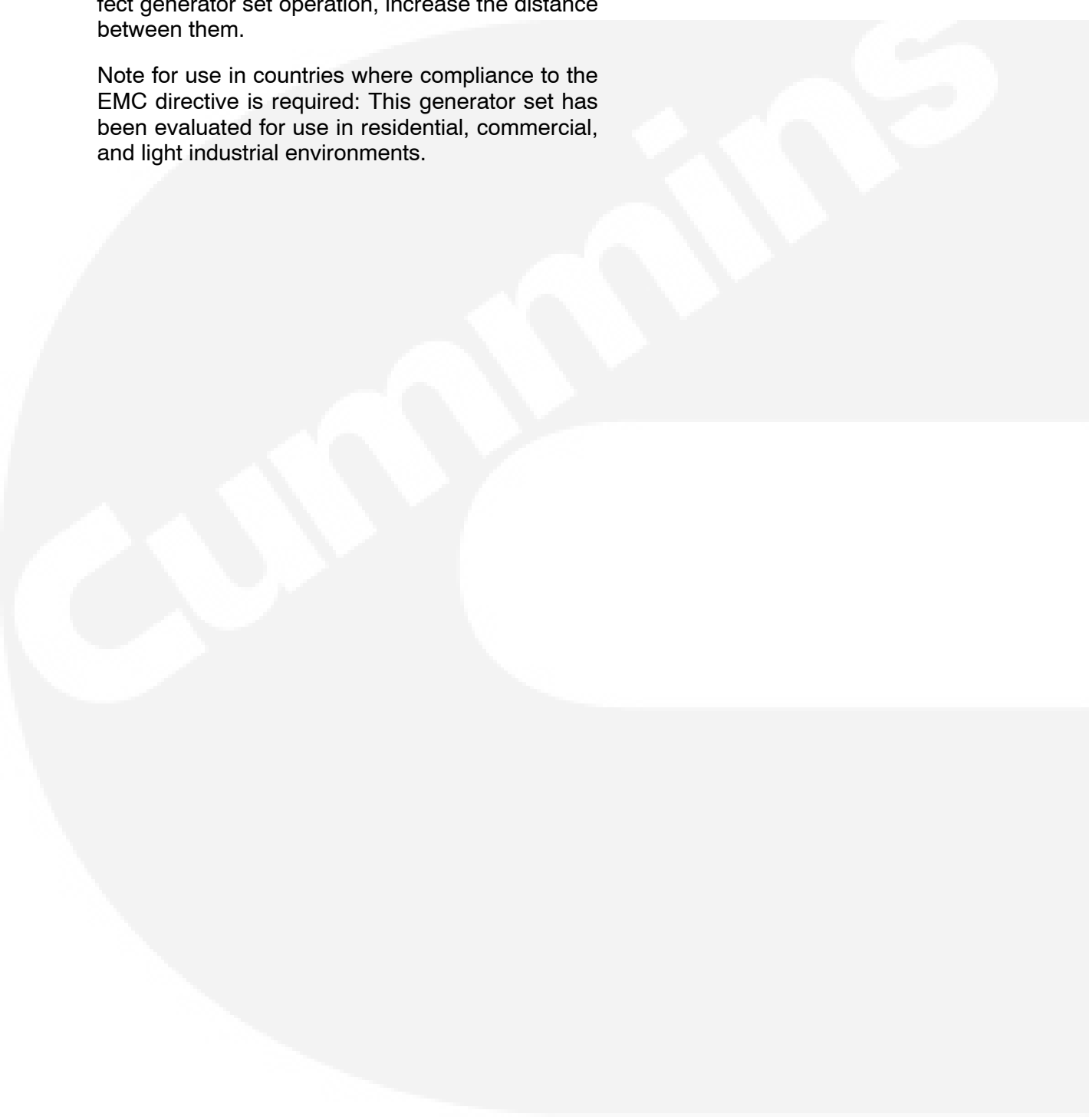

BUILD STANDARDS

The generator sets and its control system have been designed, constructed and tested generally in accordance with the following Standards where applicable. Reference Table 1-1.

TABLE 1-1. BUILD STANDARDS

BS EN 1037:1995+A1:2008	Safety of machinery – Prevent of unexpected start up.
BS EN ISO 14121-1:2007	Safety of machinery. Risk assessment. Principles
BS EN ISO 13857:2008	Safety of machinery. Safety distance to prevent hazard zones being reached by upper and lower limbs.
BS EN 349:1993+a1:2008	Safety of machinery – Minimum gaps to avoid crushing parts on the human body.
BS EN 547-1: 1996+A1:2008	Safety of machinery – Human body dimensions – Part 1: Principles of determining the dimensions required for openings for whole body access into machinery.
BS EN 547-2:1996+A1:2008	Safety of machinery – Human body dimensions – Part 2: Principles for determining the dimensions required for access openings.
BS EN 547-3:1996+A1:2008	Safety of machinery – Human body dimensions – Part 3: Anthropomorphic data.
BS EN 60204-1:2006+A1:2009	Safety of machinery. Electrical equipment of machines. General requirements
BS EN 614-1:2006+A1:2009	Safety of machinery. Ergonomic design principles. Terminology and general principles
BS EN 953:1997+A1:2009	Safety of machinery – Guards – General requirements for the design and construction of fixed and movable guards.
BS EN ISO 12100-1:2003+A1:2009	Safety of machinery. Basic concepts, general principles for design. Basic terminology, methodology
BS EN ISO 12100-2:2003+A1:2009	Safety of machinery. Basic concepts, general principles for design. Technical principles
BS EN ISO 13732-1:2008	Ergonomics of the thermal environment. Methods for the assessment of human responses to contact with surfaces. Hot surfaces
BS EN ISO 13849-1:2008	Safety of machinery – Safety related parts of control systems
BS EN ISO 13850:2006	Safety of machinery – Emergency stop. Principles for design.
BS EN 61310-1:2008	Safety of machinery – Indication, marking and actuation – Part 1: Requirements for visual, auditory and tactile signals.

BS EN 61310-2:2008	Safety of machinery – Indication, marking and actuation – Part 2: Requirements for marking.
BS EN 61000-6-1:2007	Electromagnetic compatibility (EMC). Generic standards. Immunity standard for residential, commercial and light-industrial environments
BS EN 61000-6-3:2007	Electromagnetic compatibility (EMC). Generic standards. Emission standard for residential, commercial and light-industrial environments
BS EN 1299:1997+A1:2008	Mechanical vibration and shock – Vibration isolation of machines – Information for the application of source isolation
BS EN 1679-1:1998	Reciprocating internal combustion engines – Safety – Part 1: Compression ignition engines
BS EN 12601:2001	Reciprocating internal combustion engine driven generating sets – Safety

2. Control Panel

REMOTE CONTROL AND MONITORING

Remote Control Panels

The boat may be equipped with one or more remote control panels for generator set control and monitoring. A remote control panel may consist of a control switch and status lamp or a Cummins Onan Digital Display panel. See Page 2-3 for instructions on how to use the Digital Display panel.

Boat Monitoring System

Generator set operation may also be monitored by an integrated boat equipment monitoring system that uses SAE J1939 or SmartCraft™ network protocol.

LOCAL CONTROL PANEL

The local control panel (Figure 2-1) has the following components:

Control Switch/Status Lamps (Standard)

The control switch is used to start and stop the generator set and prime fuel. It has two status lamps, green and amber.

- *Push and Hold* **START** to preheat, crank and start the generator set. The *Amber* status lamp flashes rapidly during preheat and cranking. (Preheat is the period of time prior to engine cranking when the glow plugs preheat the combustion chambers. The time is automatically varied by the generator set controller on the basis of engine temperature.)
- *Push and Release* **STOP (Prime)** to stop the generator set.

- *Push and Hold* **STOP (Prime)** to prime the fuel system. (The *Amber* status lamp lights after 2 seconds and stays on while priming.)
- The *Amber* status lamp lights during fuel priming, flashes rapidly during cranking and goes out when the engine is up to speed. It also flashes the numeric fault code if the generator set shuts down abnormally. See *Troubleshooting* (Section 5).
- The *Green* status lamp lights after starting and stays on while the generator set is running.

Digital Display Panel (Optional)

The local control panel may have a Digital Display panel instead of a control switch. See Page 2-3 for instructions on how to use the Digital Display panel.

Emergency Stop Switch

In an emergency push the switch **OFF**. Push it **ON** after all necessary repairs to the generator set and connected equipment have been made.

DC Circuit Breaker

The circuit breaker protects the DC control circuits of the generator set from short circuits. Reset after all necessary repairs have been made to the generator set.

Hour Meter

The hour meter records the accumulated number of hours of generator set operating time. It cannot be reset.

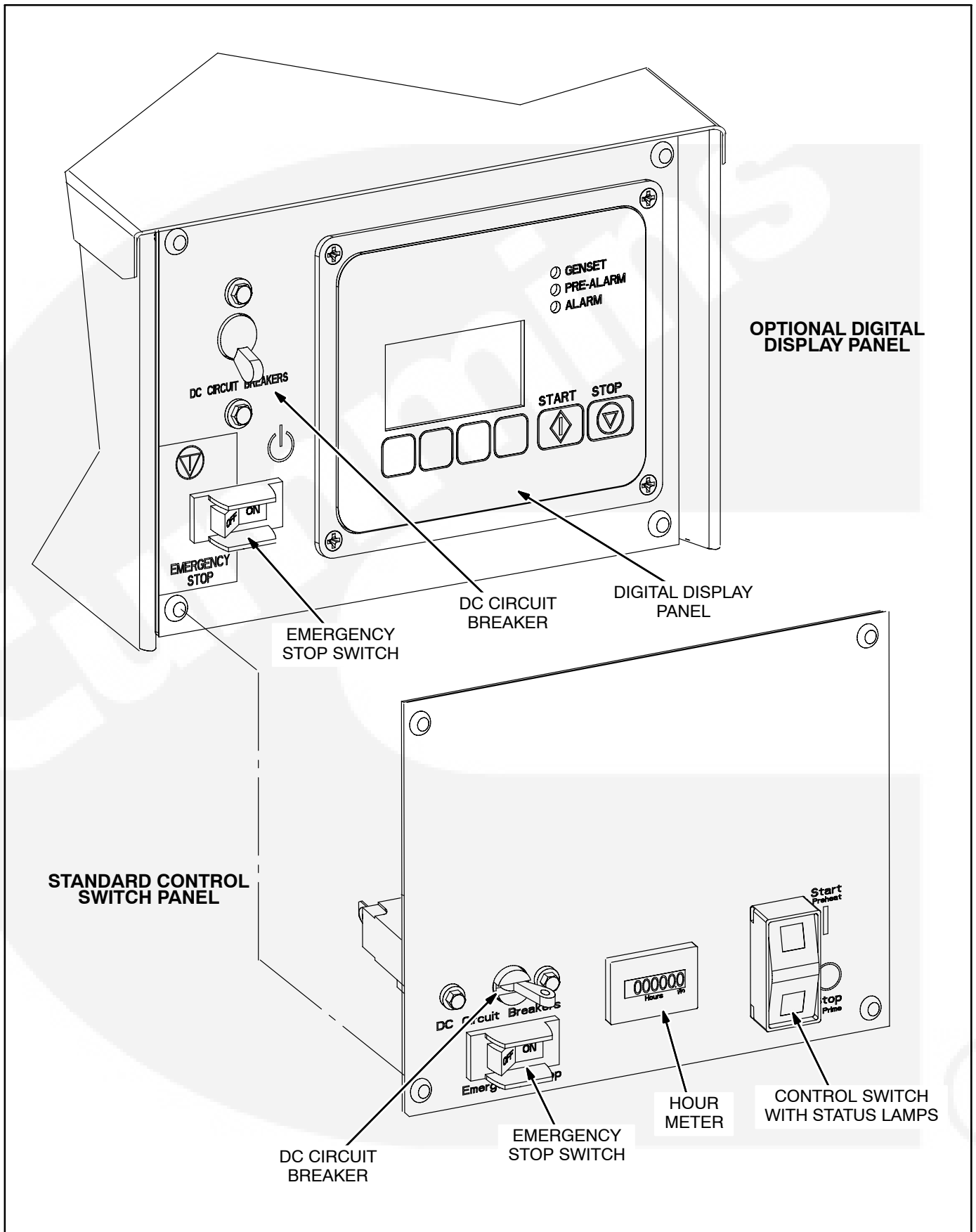

FIGURE 2-1. GENERATOR SET CONTROL PANEL

CUMMINS ONAN DIGITAL DISPLAY PANEL

The Cummins Onan Digital Display panel has an LCD screen with 4 navigation buttons, 3 status lamps, a START button and a STOP button (Figure 2-2).

Turning On the Digital Display Panel

Touch any button to turn on the Digital Display panel, which will then establish communications with the generator set. All connected Digital Display panels will turn on automatically when the generator set is started at any station. They will all turn off 5 minutes after the generator set has received a normal command to stop. If a fault occurs, they will stay on until the fault is cleared by touching any button on any Digital Display panel.

Start Button

Push and Hold START until the generator set starts. The **Generator** status lamp will blink while the engine is preheating and cranking and stay on while the generator set is running. **Status** on the Digital Display will change from *Starting* to *Running* (Figure 2-3). See STARTING THE GENERATOR SET (p. 3-3).

Stop Button

To Stop the Generator Set – *Push and Release STOP*. The **Generator** status lamp will go out. **Status** on the Digital Display will change from *Running* to *Stopped*. See STOPPING THE GENERATOR SET (p. 3-4).

To Prime Fuel – *Push and Hold STOP* for at least 30 seconds. The **Generator** status lamp will blink. **Status** on the Digital Display will change to *Priming* in 2 seconds. See PRIMING THE FUEL SYSTEM (p. 3-3).

Generator Set Status Lamps

Generator – This status lamp (green) blinks while the engine is cranking or the fuel system is being primed. It stays on while the generator set is running.

Pre-Alarm – This status lamp (amber) lights and stays on while an engine Pre-Alarm condition exists (p. 2-6).

Alarm – This status lamp (red) blinks during a fault shutdown (p. 2-5).

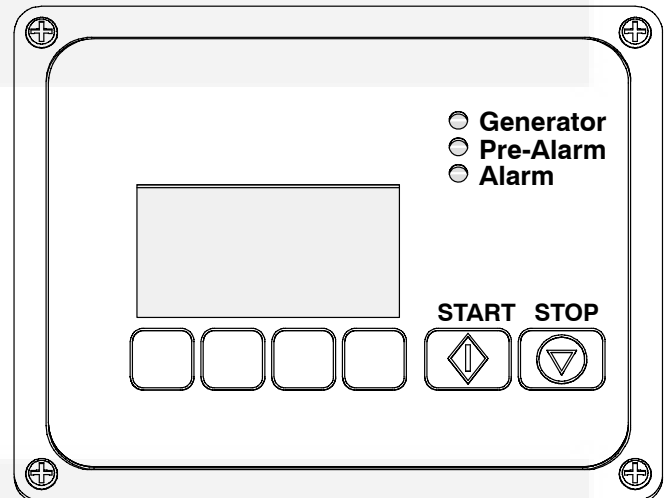

FIGURE 2-2. DIGITAL DISPLAY PANEL

Generator Set Status

Generator set status is displayed on three GEN STATUS screens (Figure 2-3). GEN STATUS Pg1 appears when the Digital Display is turned on. Press the double arrow to go to the next screen.

Status on GEN STATUS Pg1 displays the word “Priming,” “Starting,” “Running,” “Stopped” or “Volt Adj,” depending on the operating status of the generator set. The rest of the information on the three status screens includes: AC output voltage, AC frequency, engine coolant temperature, engine oil pressure, starting battery voltage and the accumulated number of hours of generator set operating time.

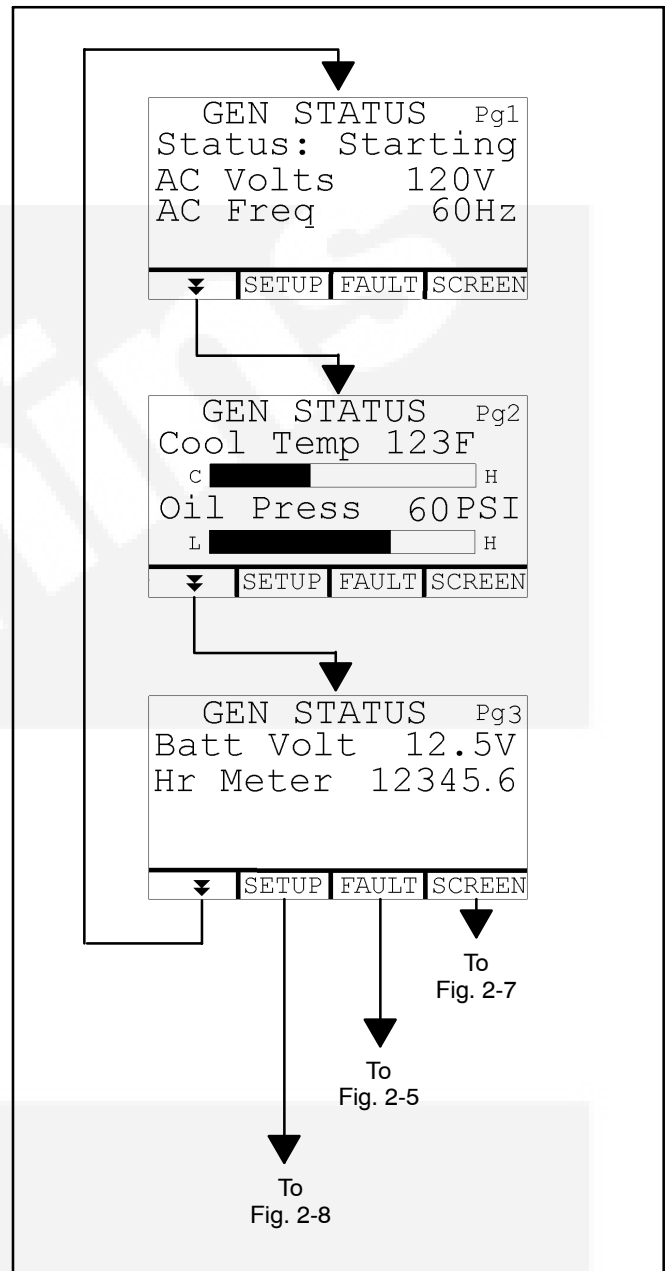

FIGURE 2-3. TYPICAL GENERATOR SET STATUS SCREENS

Fault Screen

If a fault shutdown occurs, the **Alarm** status lamp will blink and the Digital Display will display a description of the Fault, the numeric Fault code and the accumulated number of hours of generator set operating time when the Fault occurred (Figure 2-4). Refer to TABLE 5-1. TROUBLESHOOTING GENERATOR SET FAULTS to diagnose and correct the problem.

The Digital Display will display the fault indefinitely. Touch any button to clear the fault. The Digital Display will turn off in 5 minutes after the fault has been cleared.

Press **BACK** to get back to GEN STATUS.

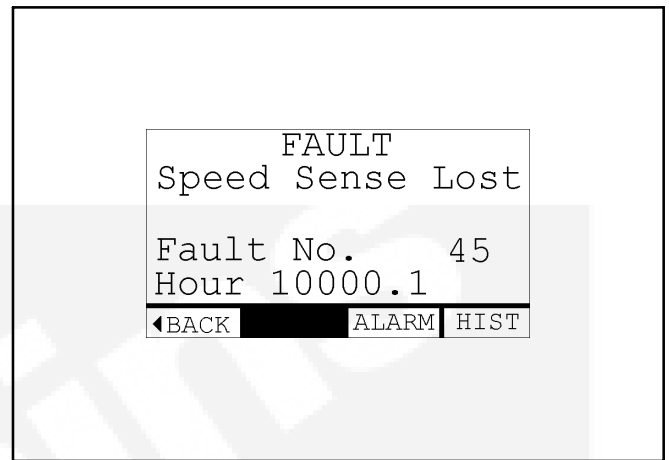

FIGURE 2-4. TYPICAL DIGITAL DISPLAY FAULT SCREEN



Fault History

To display any of the last five faults, press FAULT on any GEN STATUS screen and HIST on the FAULT screen (Figure 2-5).

The FAULT HISTORY screen displays a description of the Fault, the numeric Fault code and the accumulated number of hours of generator set operating time when the Fault occurred. Press the up or down arrow to display an earlier or later fault. If there are no faults, the FAULT HISTORY screen will display "No Stored Faults."

Press BACK to get back to GEN STATUS.

Engine Pre-Alarms

When either engine oil pressure or coolant temperature approaches its engine shutdown limit, the **Pre-Alarm** status lamp will light and the PRE-ALARM screen will display "Low Oil Pressure" or "High Engine Temperature" (Figure 2-6).

Press BACK to get back to GEN STATUS to monitor engine temperature and oil pressure and service the generator set as required.

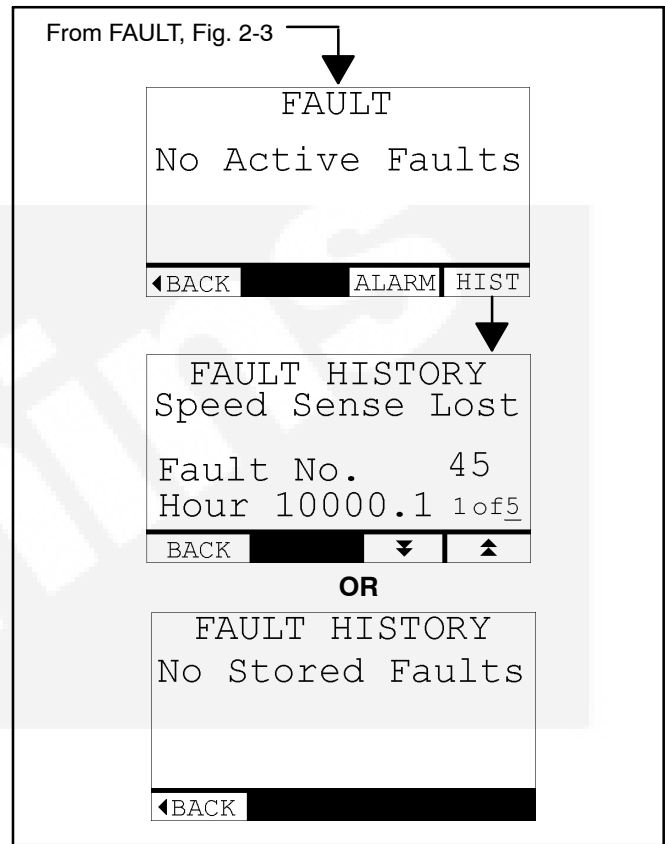

FIGURE 2-5. FAULT HISTORY

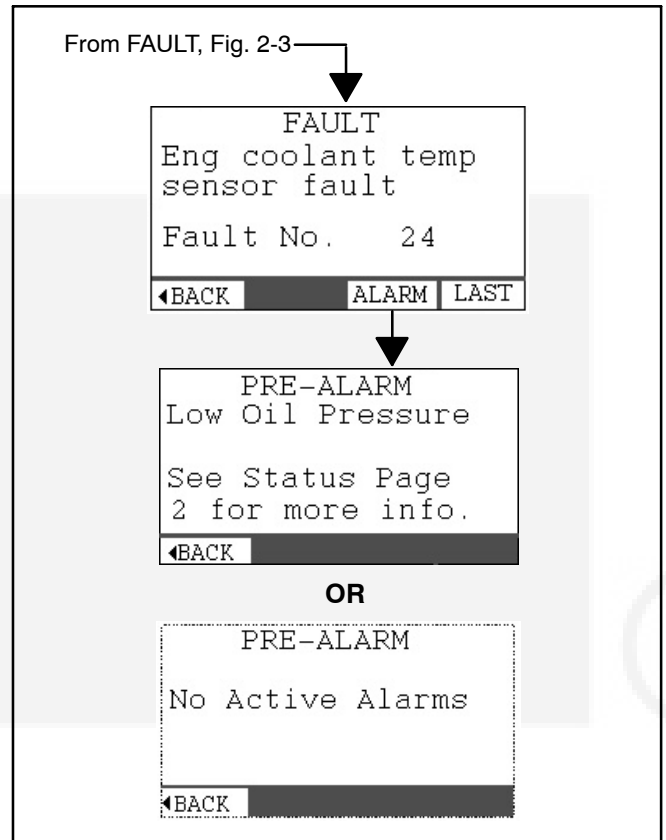

FIGURE 2-6. ENGINE PRE-ALARMS

Brightness and Contrast

Press SCREEN on any GEN STATUS screen. Press NEXT on the SCREEN ADJUST screen to select **Brightness** or **Contrast** (Figure 2-7). Press the right or left arrow to increase or decrease brightness or contrast.

Note: “Contrast” applies only to the LCD screen.

Press the BACK button to save the settings and get back to GEN STATUS.

Display Setup

Press SETUP on any GEN STATUS screen. Press the up or down arrow on the SETUP screen to select DISPLAY SETUP and press ENTER (Figure 2-8).

To select the units of measure for the GEN STATUS screens, press NEXT on the DISPLAY SETUP screen to select **Units** and then the up or down arrow to select “SAE” or “Metric”. Press BACK to save the selection and get back to GEN STATUS.

To calibrate the Digital Display Voltmeter, press NEXT on the DISPLAY SETUP screen to select **AC Voltmeter Calibration** and then press the up or down arrow to increase or decrease the voltage displayed so that it matches that of an accurate AC voltmeter (line-to-line or line-to-neutral, as desired). Press BACK to save the selection and get back to GEN STATUS.

Note: This procedure does not change AC output voltage.

⚠WARNING *Have a trained and experienced person adjust AC output voltage, if necessary, before calibrating the Digital Display Voltmeter.*

Generator Set and Display Information

Press SETUP on any GEN STATUS screen. Press the up or down arrow on the SETUP screen to select GENSET INFO or DISPLAY INFO and press ENTER (Figure 2-8). This information may be requested by the service technician. Keep pressing BACK to get back to GEN STATUS.

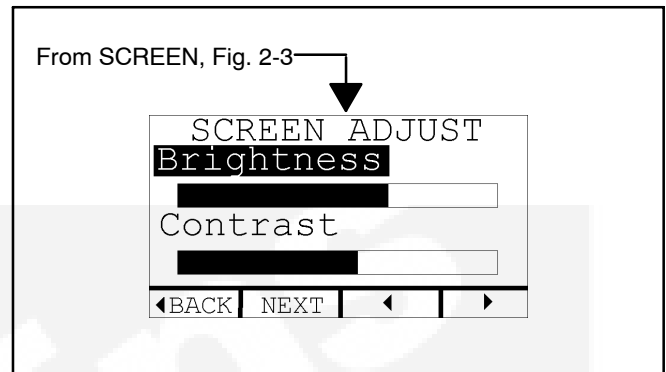

FIGURE 2-7. SCREEN BRIGHTNESS & CONTRAST

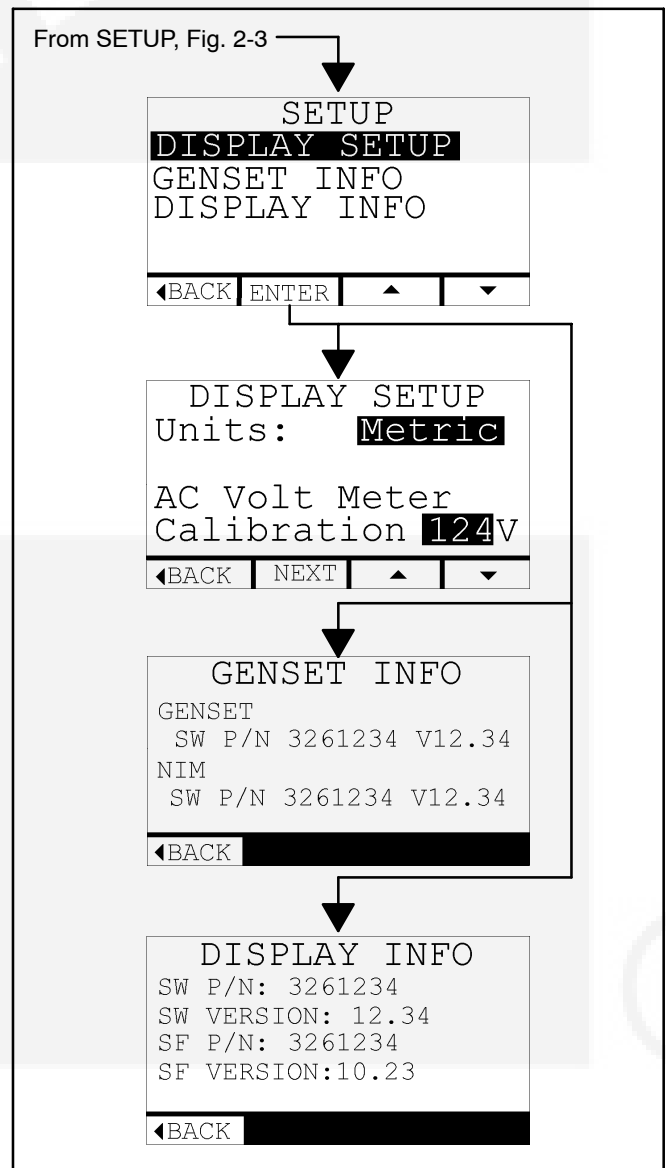

FIGURE 2-8. SETUP, GENSET & DISPLAY INFO

3. Operation

FUEL RECOMMENDATIONS

⚠WARNING Diesel fuel is combustible and can cause severe personal injury or death. Do not smoke near fuel tanks or fuel-burning equipment or in areas sharing ventilation with such equipment. Keep flames, sparks, pilot flames, electrical arcs and switches and all other sources of ignition well away. Keep a multi-class fire extinguisher handy.

High quality diesel fuel is necessary for good performance and long engine life.

- The specifications for the type and sulfur content (ppm, % weight) of the diesel fuel used must comply with all emissions regulations applicable in the areas where the genset is to be operated.
- Diesel fuels meeting ASTM D975 or EN 590 specifications are recommended. Use Grade 1-D diesel fuel where ambient temperatures are below 14° F (-10° C). A minimum Fuel Cetane Rating of 45 is recommended. Where ambient temperatures are below -4 F (-20° C), or the elevation is above 5000 ft (1500 m), a minimum Cetane Rating of 50 is recommended.
- Current US EPA regulations for Non-Road engines limit diesel fuel sulfur content to a maximum of 500 ppm (0.05% weight). Therefore, use Grade 2-D S500 or 2-D S15 diesel fuel. Where ambient temperatures are below 14° F (-10° C), use Grade 1-D S500 or 1-D S15 diesel fuel. Note that beginning in year 2010, US EPA regulations for Non-Road engines will limit diesel fuel sulfur content to a maximum of 15 ppm (0.0015% weight).
- Do not use diesel fuel having a sulfur content greater than 10,000 ppm (1.0% weight).
- Diesel fuel must meet the ASTM D975 standard for lubricity and pass a minimum load level of 3100 grams as measured by ASTM D6078, or maximum scar diameter of 0.45 mm as measured by ASTM D6079 or ISO 12156-1.
- B5 Bio-Diesel fuel that meets industry specifications and quality is suitable for use with this genset.

ENGINE OIL RECOMMENDATIONS

Oil Performance Class

Use API (American Petroleum Institute) classified engine oils according to the following guidelines:

- **Emissions-Regulated Areas:** It is mandatory to use CF, CF-4, CG-4, CH-4 or CI-4 class oil with low sulfur fuel (sulfur content less than 500 ppm, 0.05% weight) or ultra low sulfur fuel (sulfur content less than 15 ppm, 0.0015% weight).
- **Non-Regulated Areas:** CF class oil is recommended when using high sulfur fuel—sulfur content between 500 ppm (0.05% weight) and 5000 ppm (0.5% weight). If CF-4, CG-4, CH-4 or CI-4 class oil is used, the oil and oil filter must be changed twice as often as specified in the PERIODIC MAINTENANCE SCHEDULE (Page 4-1).
- **Non-Regulated Areas:** Use CF, CF-4, CG-4, CH-4 or CI-4 class oil when using high sulfur fuel—sulfur content between 5000 ppm (0.5% weight) and 10,000 ppm (1.0% weight). The oil and oil filter must be changed twice as often as specified in the PERIODIC MAINTENANCE SCHEDULE (Page 4-1).

Oil Viscosity

Look for the SAE (Society of Automotive Engineers) viscosity grade. Referring to Figure 3-1, choose the viscosity grade appropriate for the ambient temperatures expected until the next scheduled oil change. Multi-grade oils such as SAE 15W-40 are recommended for year-round use.

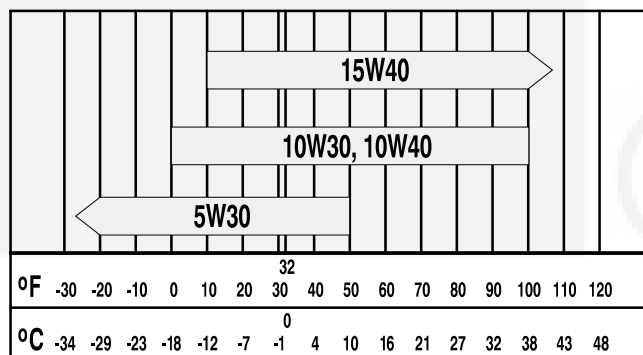

FIGURE 3-1. OIL VISCOSITY GRADE VS. AMBIENT TEMPERATURE

ENGINE COOLANT

Use the best quality ethylene glycol antifreeze solution available. It should be fully formulated with rust inhibitors and coolant stabilizers. A 50/50 mixture of water and ethylene glycol is recommended to provide protection from freezing down to -34°F (-37°C).

Use fresh water that is low in minerals and corrosive chemicals for the coolant mixture. Distilled water is best.

See *Specifications* (Section 6) regarding coolant capacity.

⚠ WARNING *Ethylene Glycol antifreeze is considered toxic. Dispose of it according to local regulations for hazardous substances.*

BATTERIES

Reliable generator set starting and starter service life depend upon adequate battery system capacity and maintenance. See MAINTAINING THE BATTERY AND BATTERY CONNECTIONS (p. 4-2) and *Specifications* (Section 6).

FIRE EXTINGUISHER PORT

The boat must have a fire extinguisher readily available for putting out a fire in the genset. It must be approved for both liquid fuel and electrical equipment.

A generator set with an enclosure has a fire extinguisher port accessible by breaking through the circle on the warning label located as shown in Figure 3-2.

⚠ CAUTION *Make sure that the nozzle of the fire extinguisher that will be used in the event of fire is smaller than the circle so that it will fit through the port. The fire extinguisher must be of the gaseous type.*

In the event of fire:

1. DO NOT open the generator set enclosure.
2. Shut down engines, generators and blowers.
3. Break through the circle on the label with the nozzle and discharge the full contents of the fire extinguisher.

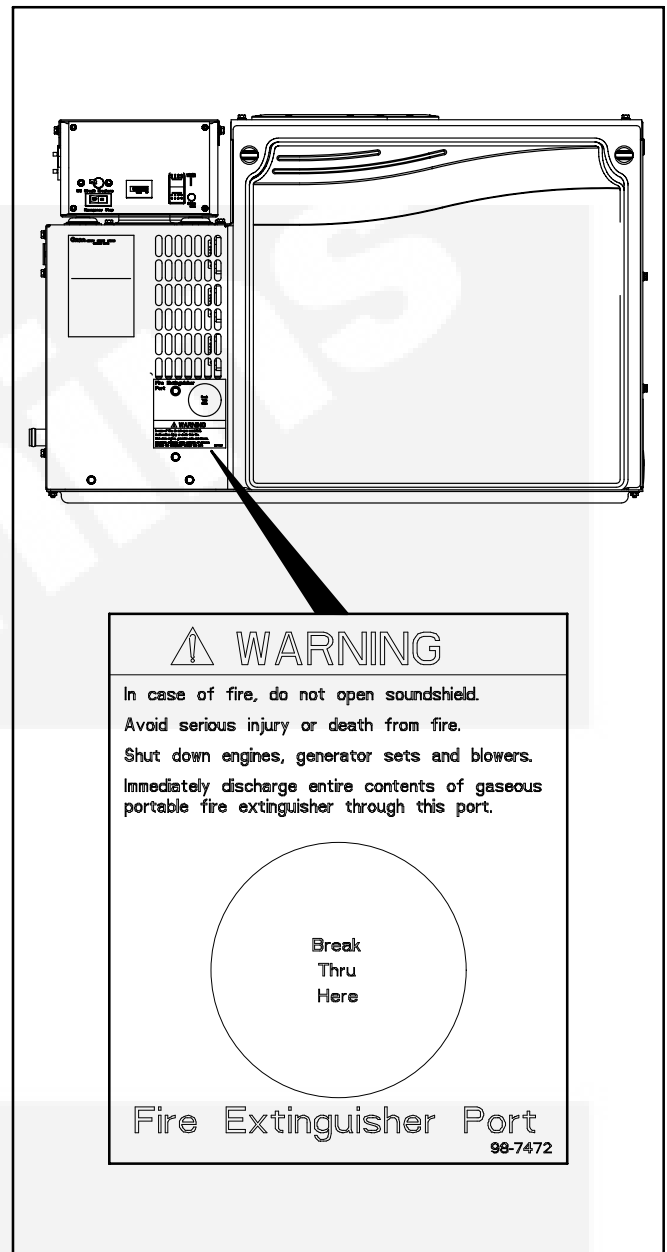

FIGURE 3-2. FIRE EXTINGUISHER PORT

PRE-START CHECKS

⚠ WARNING *EXHAUST GAS is deadly. All engine exhaust contains carbon monoxide; an odorless, colorless, poisonous gas that can cause unconsciousness and death. Symptoms of carbon monoxide poisoning include:*

- *Dizziness*
- *Headache*
- *Nausea*
- *Weakness and Sleepiness*
- *Vomiting*
- *Inability to Think Coherently*

GET EVERYONE OUT INTO FRESH AIR IMMEDIATELY IF ANYONE EXPERIENCES ANY OF THESE SYMPTOMS. Seek medical attention if symptoms persist. Never sleep in the boat when the generator set is running, unless the cabin has a working carbon monoxide detector.

Look over the entire exhaust system and listen for leaks every time you start up the generator set and after every eight hours of operation. Shut down the generator set immediately if there is a leak. Do not run the generator set until the leak has been repaired. The exhaust system must be installed in accordance with the generator set Installation Manual.

Before the first start of the day and after every eight hours of operation, inspect the generator set as instructed under GENERAL INSPECTION (p. 4-2). Keep a log of maintenance and the hours run and perform any maintenance that may be due. See Returning the Generator Set to Service (p. 3-6) if the boat has been in storage. Before each start:

1. Make sure all CO detectors on board are working properly.
2. Check for swimmers that might be exposed to the engine exhaust.
3. Disconnect all electrical loads and disengage the PTO (if so equipped).

PRIMING THE FUEL SYSTEM

The fuel system should be primed after replacing the fuel filter or running the generator set out of fuel. To prime the fuel system, *Push and Hold STOP* on the Digital Display or **STOP (Prime)** on the control switch for at least 30 seconds.

STARTING THE GENERATOR SET

The generator set can be started and stopped from the generator set control panel or remote control panel.

1. Visually inspect for water, coolant, fuel and exhaust leaks. Do not start the generator set if there is a leak. Repair fuel leaks immediately.
2. *Push and Hold START* on the Digital Display or control switch until the generator set starts. The generator set status lamp blinks when the engine is cranking and comes on and stays on when the generator set starts and runs. The status displayed on the Digital Display changes from *Starting* to *Running* (Figure 2-3).
3. For longer engine life, let the engine warm up for two minutes before connecting air conditioners and other large electrical loads or engaging the PTO (if so equipped).
4. Monitor generator set status using the Digital Display (p. 2-4), if so equipped. Perform maintenance or service as necessary if the Digital Display indicates a **Pre-Alarm** condition (p. 2-3).
5. **If the generator set fails to start**, cranking will discontinue in 20 to 60 seconds, depending on engine temperature. The Digital Display and/or control switch status lamp will indicate Fault Code No. 4. See *Troubleshooting* (Section 5) if the generator set does not start after several tries.

⚠ CAUTION *Do not continue cranking and risk burning out the starter or flooding the engine (exhaust flow during cranking is too low to expel water from a wet exhaust system). Find out why the generator set does not start and make necessary repairs.*

6. **If the generator set shuts down**, the Digital Display and/or control switch status lamp will indicate the numeric fault code. See *Troubleshooting* (Section 5).

STOPPING THE GENERATOR SET

Disconnect all electrical loads and disengage the PTO (if so equipped) to let the generator set run without load and cool down. After 2 minutes *Push and Release STOP* on the Digital Display or control switch. The generator set status lamps will go out.

CAUTION “After Boil” can force large amounts of coolant through the pressure cap and coolant recovery tank. Always let the engine cool down before stopping the generator set. Check for loss of coolant after every emergency stop of fault shutdown. Refill and clean up as necessary.

EMERGENCY STOP

Push the **EMERGENCY STOP SWITCH** to **OFF** (p. 2-1). After all necessary repairs have been made, push the switch to **ON** so that the generator set can be operated.

LOADING THE GENERATOR SET

The power rating (KW) on the generator set nameplate determines how much electrical load (motors, fans, pumps, heaters, air conditioners, appliances, etc.) the generator set can power. The generator set will shut down or its line circuit breakers will trip if the sum of the concurrent electrical loads exceeds the generator set power rating.

To avoid shutdowns due to overloading the generator set, compare the sum of the electrical loads that are likely to be used at the same time to the generator set power rating. Use the electrical ratings on the nameplates of motors, fans, pumps and other such equipment. Refer to Table 3-1 for typical appliance ratings. If the equipment is marked in amps and volts only, multiply the amps times the volts to obtain the load in watts. Divide watts by 1000 to obtain load in terms of kilowatts (KW).

It may be necessary to run fewer electrical loads and appliances at the same time—the sum of the loads must not be greater than the generator set power rating.

The generator set may shut down due to overloading when a large motor or air conditioner is started or

cycles off and then on again, even though the sum of the electrical loads is less than the generator set power rating. The reason for this is that a motor's startup load is much greater than its running load.

It may be necessary to run fewer electrical loads and appliances when large motors and air conditioners are cycling on and off.

On generator sets so equipped, the PTO can take most, if not all, of the power available from the engine. The boat builder may have made provisions to automatically disconnect all or most electrical loads when the PTO is engaged.

It may be necessary to run fewer electrical loads and appliances—or none at all—when the PTO is engaged.

The generator set is rated at standard barometric pressure, humidity and temperature (ref. ISO 3046). Either low barometric pressure (high altitude) or high ambient temperature will decrease engine power.

It may be necessary to run fewer electrical loads and appliances when ambient temperatures are higher than normal.

TABLE 3-1. TYPICAL APPLIANCE LOADS

Appliance	Load (watts)
Air Conditioner	1400-2000
Battery Charger	Up to 3000
DC Converter	300-700
Refrigerator	600-1000
Microwave Oven	1000-1500
Electric Frying Pan or Wok	1000-1500
Electric Stove Element	350-1000
Electric Water Heater	1000-1500
Electric Iron	500-1200
Electric Hair Dryer	800-1500
Coffee Percolator	550-750
Television	200-600
Radio	50-200
Electric Drill	250-750
Electric Broom	200-500
Electric Blanket	50-200

NO-LOAD OPERATION

Keep no-load operation to a minimum. During no-load operation cylinder temperatures drop to the point where fuel does not burn completely, causing fuel wetting and white smoke. It is best to run the generator set at 1/4 to 3/4 load.

RESETTING LINE CIRCUIT BREAKERS

Connecting too many electrical loads and appliances can trip the line circuit breakers on the generator set or on the boat's power distribution panel. Note that the generator set will continue to run if its circuit breaker trips.

If a circuit breaker trips, disconnect or turn off as many electrical loads and appliances as possible. Then reset the circuit breaker and reconnect the loads and appliances one-by-one, making sure not to overload the generator set or cause a circuit breaker to trip.

An electrical load or appliance probably has a short if it trips a circuit breaker immediately when it is connected. Electrical equipment must be used and maintained properly and be properly grounded to cause the line circuit breakers to trip when short circuits occur.

⚠WARNING *Short circuits in electrical equipment can cause fire and electrical shock leading to severe personal injury or death. Electrical equipment and its grounding must be maintained properly to protect against short circuits.*

CONNECTING TO SHORE POWER

When provisions have been made for connecting shore power, the boat must have an approved device to keep the generator set and shore power from being interconnected.

⚠WARNING *Interconnecting the generator set and shore power can lead to electrocution of utility line workers, equipment damage and fire. Use an approved switching device to prevent interconnections.*

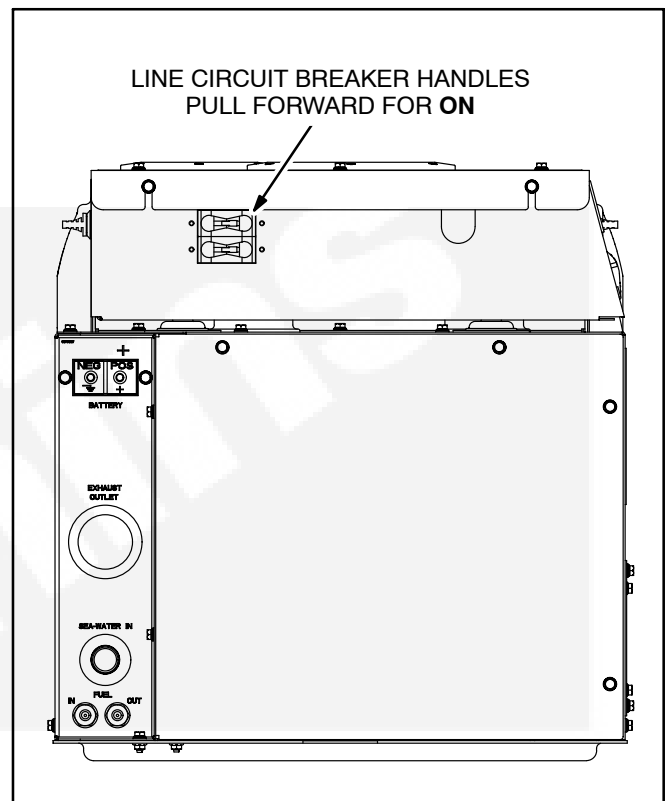

FIGURE 3-3. TYPICAL LINE CIRCUIT BREAKERS

COLD TEMPERATURE OPERATION

Drain the heat exchanger (p. 4-8) and muffler before cold weather sets in if the generator set is not being used. Freezing water can damage the muffler and the raw water tubes in the heat exchanger.

CARE OF NEW OR RE-BUILT ENGINE

Avoid no-load operation as much as possible during break-in. Change the oil and oil filter after the first 50 hours of operation (p. 4-3).

EXERCISING THE GENERATOR SET

Exercise the generator set at least 1 hour every month if use is infrequent. Run the generator set at 1/4 to 3/4 load. A single exercise period is better than several shorter periods. Exercising a generator set drives off moisture, re-lubricates the engine, uses up fuel before it becomes stale and removes oxides from electrical contacts. The result is better starting, more reliable operation and longer engine life.

STORING THE GENERATOR SET

Proper storage is essential for preserving top generator set performance and reliability when the generator set cannot be exercised regularly and will be idle for more than 120 days.

Storing the Generator Set

1. Turn off the generator set line circuit breaker.
2. Change the engine oil and filter and attach a tag indicating oil viscosity. See ENGINE OIL RECOMMENDATIONS (p. 3-1).
3. Crank the engine several revolutions but do not let it start. This will fill the oil passages with the new oil.

4. Disconnect the battery cables (negative [-] cable first) from the starting battery and store the battery according to the battery manufacturer's recommendations. See MAINTAINING THE BATTERY AND BATTERY CONNECTIONS (p. 4-2).

5. Check coolant level and add as necessary (p. 4-7). Test the coolant mixture if freezing temperatures are possible and change if necessary.

⚠WARNING *Hot coolant is under pressure and can cause severe burns when loosening the pressure cap. Let the engine cool before loosening the pressure cap.*

6. Drain the heat exchanger and muffler if freezing temperatures are expected.
7. Disengage a PTO clutch if so equipped.
8. Clean and lightly oil parts that can rust.

Returning the Generator Set to Service

1. Check the oil tag on the generator set and change the oil if the viscosity indicated is not appropriate for the temperatures expected. See ENGINE OIL RECOMMENDATIONS (p. 3-1).
2. Reconnect the starting battery (negative [-] cable last). See MAINTAINING THE BATTERY AND BATTERY CONNECTIONS (p. 4-2).
3. Replace the raw water pump impeller if it was installed more than a year ago (p. 4-12).
4. Perform the maintenance required (p. 4-1), conduct the pre-start checks and prime the fuel system.
5. Start and run the generator set.
6. Turn on the generator set line circuit breaker when ready to power loads.

4. Periodic Maintenance

Periodic maintenance is essential for top performance and long generator set life. Use Table 4-1 as a guide for normal periodic maintenance.

Maintenance, replacement or repair of emission control devices and systems may be performed by any engine repair establishment or individual. However, warranty work must be completed by an authorized Cummins Onan service representative.

To help you keep generator set maintenance regular and provide a basis for warranty claims, record maintenance performed in *Maintenance Record* (Section 7).

⚠WARNING *Accidental or remote starting can cause severe personal injury or death. Disconnect the negative (-) cable at the battery to prevent starting while working on the generator set.*

TABLE 4-1. PERIODIC MAINTENANCE SCHEDULE

MAINTENANCE OPERATION	MAINTENANCE FREQUENCY									
	After First 50 Hrs	Every Day / 8 Hrs	Every Month/ 100 Hrs	Every Year/ 200 Hrs	Every Year/ 350 Hrs	Every Year/ 500 Hrs	Every 800 Hrs	Every 2 Years	Every 5 Years/ 2000 Hrs	Page
General Inspection ¹		•								4-2
Check Engine Oil Level		•								4-3
Drain Water from Fuel Filter			•							4-6
Inspect Battery and Battery Connections ²			•							4-2
Check V-Belt Tension ⁵			•							4-13
Inspect Siphon Break			•							4-8
Change Engine Oil and Oil Filter— All except MDKBT & MDKBU ⁴	•			•						4-3
Change Engine Oil and Oil Filter— Only MDKBT & MDKBU ⁴	•				•					4-3
Replace Fuel Filters						•				4-6
Inspect Zinc Anode						•				4-8
Replace Raw Water Impeller						•				4-12
Adjust Engine Valve Lash ⁵							•			-
Replace Coolant, Pressure Cap								•		4-7
Inspect Generator Bearing ⁵									•	-

1 - Includes inspection of Oil Level, Coolant Level, Fuel System, Exhaust System, Batteries and Battery Connections.
 2 - See battery manufacturer's recommendations.
 3 - Check for slippage, cracking and wear.
 4 - Perform twice as often when using high sulfur fuel. See ENGINE OIL RECOMMENDATIONS (Page 3-1).
 5 - Must be performed by a qualified mechanic (authorized Cummins Onan dealer).

GENERAL INSPECTION

Inspect the generator set before the first start of the day and after every eight hours of operation.

Oil Level

Check engine oil level (p. 4-3).

Exhaust System

Inspect the exhaust system for leaks and loose hose clamps at the exhaust manifold, exhaust elbow, muffler, water separator and hull fittings. Replace damaged sections of exhaust hose.

Check that all CO monitors are working properly.

▲WARNING ***EXHAUST GAS IS DEADLY! Do not operate the generator set until all exhaust leaks have been repaired.***

Fuel System

Check for leaks at hose, tube and pipe fittings in the fuel supply and return systems while the generator set is stopped. Check flexible fuel hose for cuts, cracks, abrasions and loose hose clamps. Make sure fuel lines do not rub against other parts. Replace worn or damaged fuel line parts before leaks occur. Replace hose with a USCG TYPE A1 or ISO 7840-A1 fuel hose.

Prime the fuel system if the generator set ran out of fuel.

▲WARNING ***Fuel leaks can lead to fire. Repair leaks immediately. Do not run the generator set if it causes fuel to leak.***

Coolant Level

Check coolant level in the recovery tank and, if necessary, refill the recovery tank to COLD when the engine is cold or to HOT when it is at normal running temperature. The recovery tank is designed to maintain coolant level, not to fill the system. If the tank is empty, check for and repair any coolant leaks and refill the system through the fill neck on the engine. See Refilling the Cooling System (p. 4-8). Use the recommended antifreeze mixture (p. 3-2).

Raw Water System

Clean out the sea water strainer if necessary and make sure the sea valve is open for generator set

operation. Also, when a water/exhaust separator is provided, open the sea valve for the water drain hose.

Check for hoses that leak or are damaged. Have a qualified service person replace any leaking or damaged hoses.

Mechanical

Monitor generator set status using the Digital Display (p. 2-4).

Visually inspect genset for mechanical damage. For generator sets with a sound shield, install service doors before running the generator set to listen for unusual noises. Check the generator set mounting bolts. Check to see that the generator set air inlet and outlet openings are not clogged with debris or blocked. Keep the generator set compartment clean.

MAINTAINING THE BATTERY AND BATTERY CONNECTIONS

▲WARNING ***Arcing at battery terminals or in light switches or other equipment, and flames or sparks, can ignite battery gas causing severe personal injury—Ventilate battery area before working on or near battery—Wear safety glasses—Do not smoke—Switch work light ON or OFF away from battery—Stop generator set and disconnect charger before disconnecting battery cables—Disconnect negative (-) cable first and reconnect last.***

Refer to Table 4-1 for scheduled battery maintenance, and follow the battery manufacturer's instructions. Have the battery charging system serviced if DC system voltage is consistently low or high.

Check the battery terminals for clean, tight connections. Loose or corroded connections have high electrical resistance which makes starting harder. Always:

1. Keep the battery case and terminals clean and dry and the terminals tight.
2. Remove battery cables with a battery terminal puller.
3. Make sure which terminal is positive (+) and which is negative (-) before making battery connections, always removing the negative (-) cable first and reconnecting it last to reduce arcing.

CHECKING ENGINE OIL LEVEL

⚠️WARNING *State and federal agencies have determined that contact with used engine oil can cause cancer or reproductive toxicity. Avoid skin contact and breathing of vapors. Use rubber gloves and wash exposed skin.*

⚠️CAUTION *Too little oil can cause severe engine damage. Too much oil can cause high oil consumption.*

⚠️WARNING *Engine components (drains, filters, hoses, etc) will be hot and can cause severe burns. The use of protective gloves is recommended.*

Shut off the generator set and check the oil level with the dip stick (Figure 4-1, 4-2 or 4-3). Add or drain oil as necessary. Add 1 quart (0.9 liters) when the level falls to the ADD mark. Drain oil if the level is above the full mark.

See ENGINE OIL RECOMMENDATIONS (p. 3-1).

CHANGING ENGINE OIL AND FILTER

Refer to Table 4-1 for scheduled engine oil change.

1. Run the generator set under load until it is up to operating temperature, stop it and disconnect the negative (-) battery cable at the battery.

⚠️WARNING *Accidental or remote starting can cause severe personal injury or death. Disconnect the negative (-) cable at the battery to prevent the engine from starting.*

⚠️WARNING *Engine components (drains, filters, hoses, etc) will be hot and can cause severe burns. The use of protective gloves is recommended.*

2. Be ready to drain the oil into a suitable container and then open the drain valve or unscrew the plug on the end of the drain hose (Figure 4-1, 4-2 or 4-3) and drain the oil into a suitable container. (Two wrenches are necessary to keep from twisting the hose when loosening and tightening the plug.) If an oil pump-out system is installed, follow the instructions provided.
3. *Secure the drain plug or close the oil drain valve.*
4. Spin off the old oil filter with a filter wrench and wipe off the filter mounting surface. Remove the old gasket if it does not come off with the filter.
5. Apply a film of oil to the new filter gasket and partly fill the new filter with oil so that it reaches engine parts sooner at startup. Spin the filter on by hand until the gasket just touches the mounting pad and tighten 3/4 turn.
6. Refill the engine with the proper type and amount of engine oil. See ENGINE OIL RECOMMENDATIONS (p. 3-1) and *Specifications* (Section 6). Check the oil level and add or drain oil as necessary. Install service doors on generator sets that have a sound shield. Run the generator for a few minutes, shut it down and recheck for proper oil level.
7. Dispose of the used oil and oil filter according to local environmental regulations.



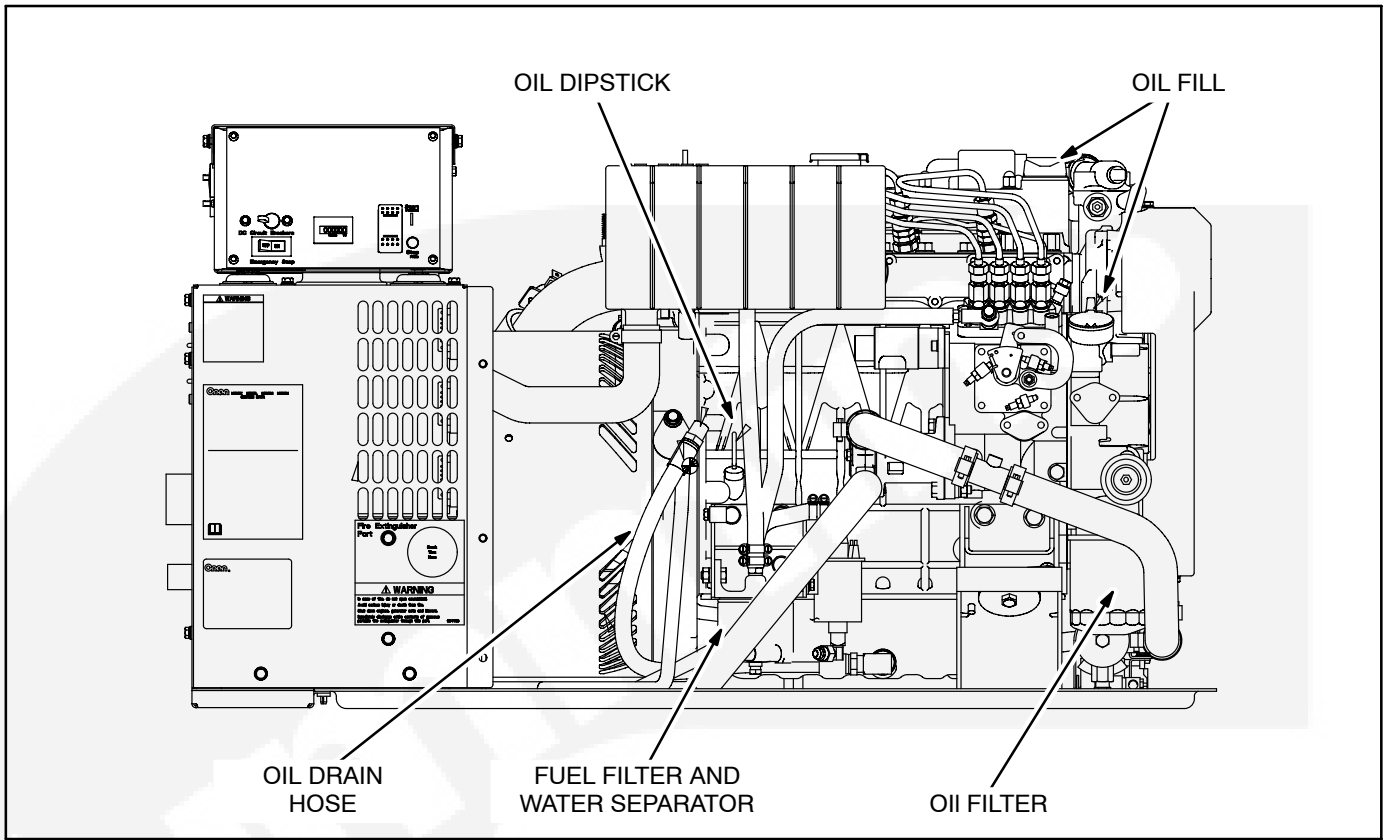

FIGURE 4-1. OIL AND FUEL SERVICE POINTS—MDK BK, MDK BL, MDK BM, MDK BN

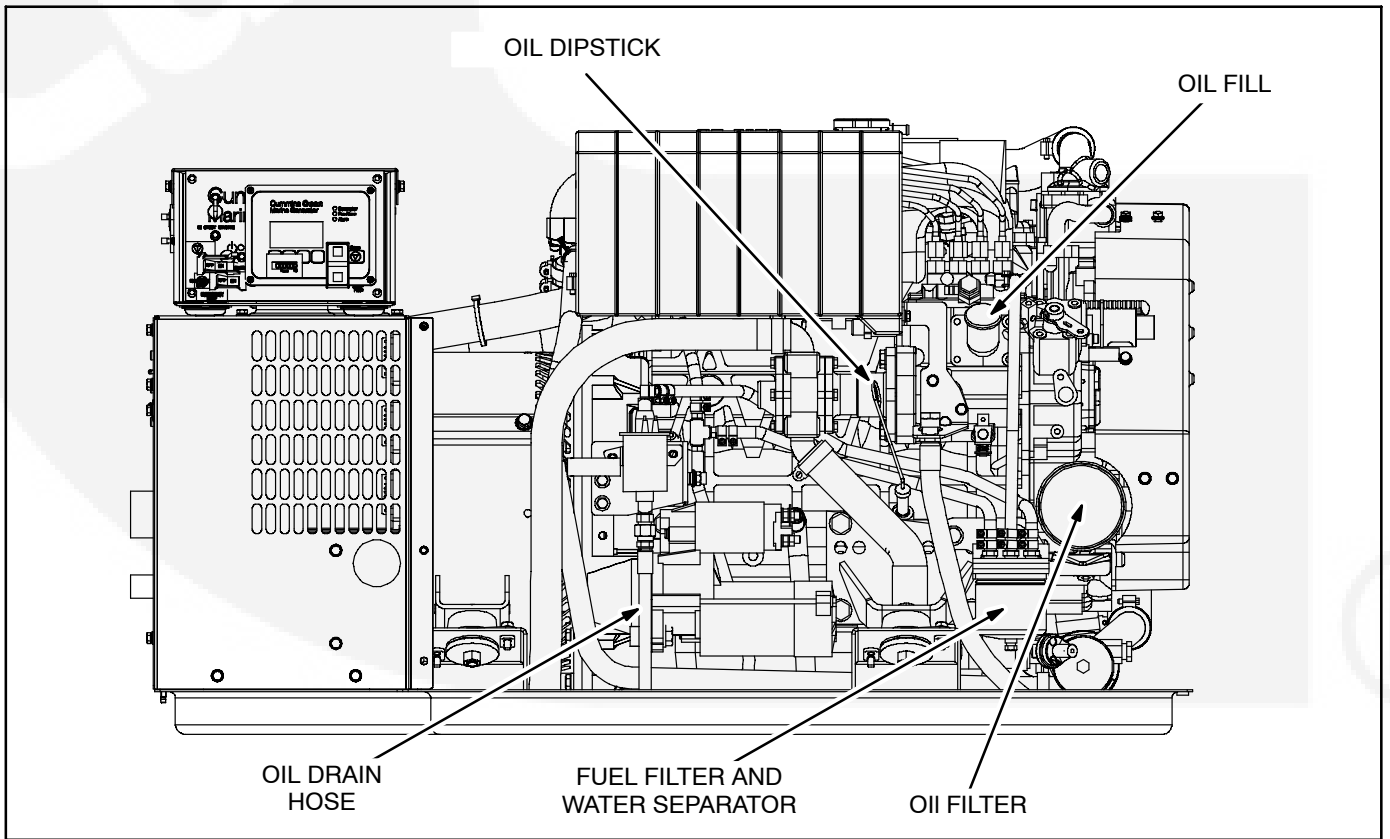

FIGURE 4-2. OIL AND FUEL SERVICE POINTS—MDK BP, MDK BR, MDK BV

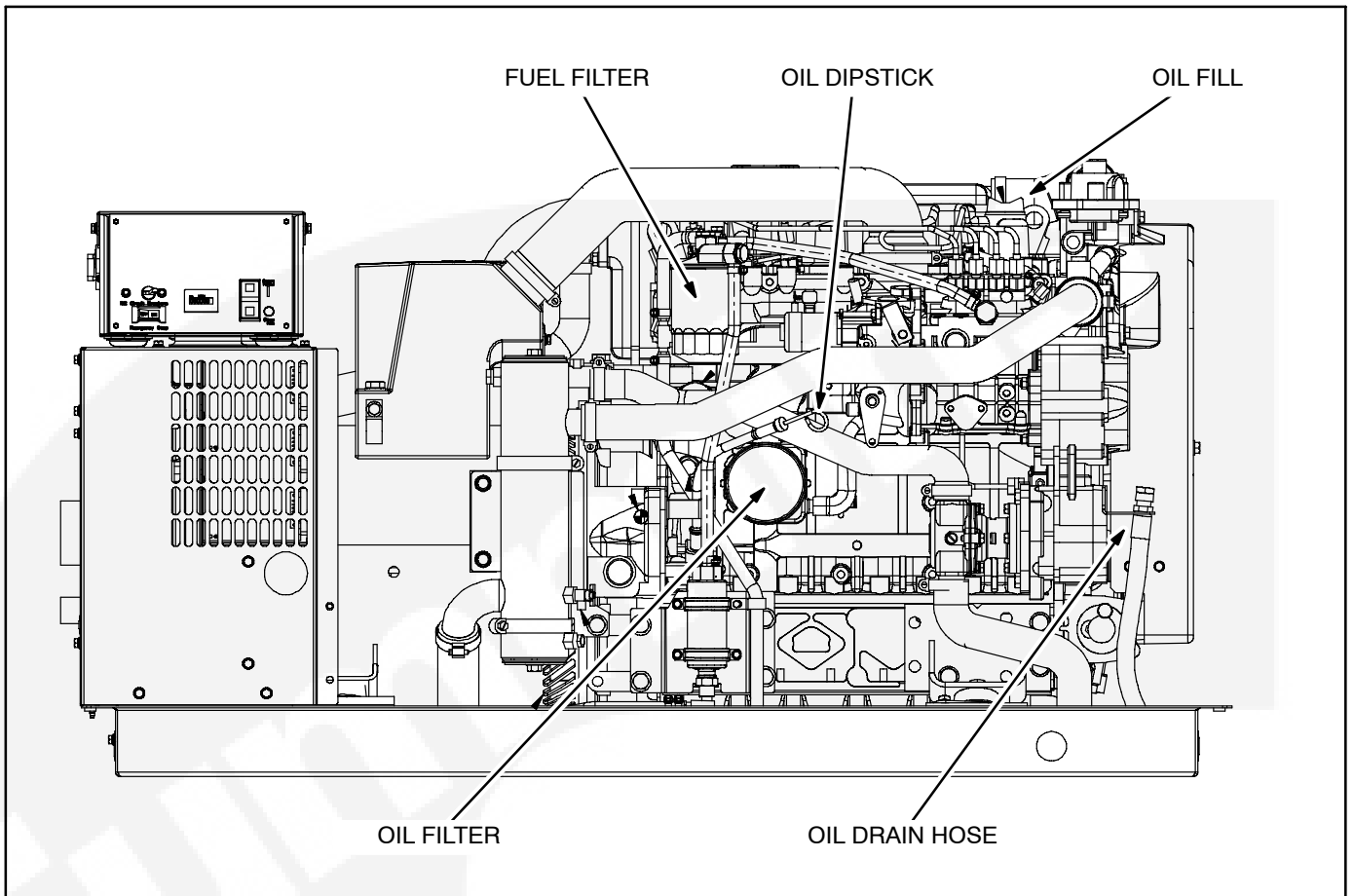

FIGURE 4-3. OIL AND FUEL SERVICE POINTS—MDKBT, MDKBU

DRAINING/REPLACING FUEL FILTERS

⚠WARNING *Diesel fuel is combustible and can cause severe personal injury or death. Do not smoke near fuel tanks or fuel-burning equipment or in areas sharing ventilation with such equipment. Keep flames, sparks, pilot flames, electrical arcs and switches and all other sources of ignition well away. Keep a multi-class fire extinguisher handy.*

Keep dirt, water and other contaminants from entering the fuel system and corroding or clogging fuel injection components.

Draining Water and Sediment: The generator set may have a water-separator type of fuel filter (Figure 4-1, 4-2). Also check for up-stream water-separator type fuel filters. Drain water and sediment more often than scheduled (Table 4-1) if fuel quality is poor or condensation cannot be avoided. Dispose of the water, sediment and fuel drained off in accordance with local environmental regulations.

Replacing Fuel Filters: See Table 4-1 for scheduled fuel filter replacement. Replace fuel filters (Figure 4-1, 4-2 or 4-3) if the engine lacks power.

1. Disconnect the negative (-) cable at the battery to prevent the engine from starting and close any fuel supply and return valves.

⚠WARNING *Accidental or remote starting can cause severe personal injury or death. Disconnect the negative (-) cable at the battery to prevent the engine from starting.*

⚠WARNING *Engine components (drains, filters, hoses, etc) will be hot and can cause severe burns. The use of protective gloves is recommended.*

2. Spin off the old filter with a filter wrench and dispose of it in accordance with local environmental regulations.
3. Clean the contact surface on the filter base, lubricate the new filter gasket and spin the new filter on hand tight.
4. Prime the engine for at least 30 seconds (p. 3-3) to fill the new filter. Install service doors on generator sets that have a sound shield. Run the generator for a few minutes, shut it down and check for leaks. Tighten the filter by hand, if necessary.



MAINTAINING THE ENGINE COOLING SYSTEM

Refer to Table 4-1 for scheduled maintenance.

Cooling System Overview

The engine is cooled by a pressurized, closed-loop liquid cooling system in which coolant is pumped through passages in the engine block, head and exhaust manifold (Figure 4-4, 4-5 or 4-6). Heat is carried away from the coolant by a keel cooler or raw water (sea water) heat exchanger. A gear-driven raw water pump is provided if the generator set has a heat exchanger or wet exhaust.

Keel Cooler: A keel cooler, when provided, is part of the pressurized, closed-loop liquid cooling system through which the coolant flows.

Heat Exchanger: When a heat exchanger is provided, raw water (the floatation water) is pumped through tubes in the heat exchanger to cool the engine coolant. The water is then passed through a hose into the exhaust-water mixer to cool the exhaust gases. The raw water is expelled from the boat along with the exhaust gases.

Recommended Coolant Mixture

See ENGINE COOLANT (p. 3-2) for recommendations.

Replenishing Normal Coolant Loss

Check coolant level in the recovery tank before the first startup of each day and, if necessary, refill to COLD when the engine is cold or to HOT when it is running. The recovery tank is designed to maintain coolant level, not to fill the system. If the tank is empty, check for and repair any coolant leaks and refill the system through the fill neck on the engine.

Pressure Cap

⚠️WARNING *Let the engine cool down before removing the coolant pressure cap or opening the coolant drain. Hot coolant under pressure can spray and cause severe burns. Wear safety glasses*

Replace the pressure cap every two years (seals deteriorate and leak). Proper cooling system pressure (7 psi) is essential for optimal engine cooling and minimal coolant loss.

Coolant Hoses

⚠️WARNING *Engine components (drains, filters, hoses, etc) will be hot and can cause severe burns. The use of protective gloves is recommended.*

Check for hoses that leak or are damaged. Have a qualified service person replace and leaking or damaged hoses.

Draining and Cleaning Cooling System

Have towels and containers ready to wipe up, collect and properly dispose of the coolant. Disconnect the negative (-) cable at the battery to prevent the engine from starting and let the engine cool before removing the pressure cap.

⚠️WARNING *Accidental or remote starting can cause severe personal injury or death. Disconnect the negative (-) cable from the battery to prevent the engine from starting.*

⚠️WARNING *Let the engine cool down before removing the coolant pressure cap or opening the coolant drain. Hot coolant under pressure can spray and cause severe burns. Wear safety glasses*

⚠️WARNING *Engine components (drains, filters, hoses, etc) will be hot and can cause severe burns. The use of protective gloves is recommended.*

Remove the pressure cap and open the block and heat exchanger drain valves (Figure 4-4, 4-5 or 4-6) and drain the coolant into suitable containers for disposal in accordance with the local regulations for hazardous substances.

Drain or flush a keel cooler in accordance with the manufacturer's instructions.

Use radiator cleaning chemicals to clean and flush the cooling system before refilling with fresh coolant. Follow the cleaner manufacturer's instructions.

⚠️CAUTION *Filling a hot engine with cold water can cause cracks in the manifold, head and block. Follow the manufacturer's instructions for cleaning and flushing.*

Refilling Cooling System

Close the block and heat exchanger drain valves and fill the system through the engine fill neck. The system will fill only as fast as the air can escape. Fill to the bottom of the fill neck. Install service doors on generator sets that have a sound shield. Start and run the engine for a couple of minutes to dislodge air pockets and shut it down. Add as much coolant as necessary and secure the pressure cap. Then refill the recovery tank up to the COLD mark.

CAUTION *Low coolant level can cause severe engine damage. Make sure the system is full.*

Heat Exchanger

WARNING *Engine components (drains, filters, hoses, etc) will be hot and can cause severe burns. The use of protective gloves is recommended.*

Both ends of the heat exchanger (Figure 4-4, 4-5 or 4-6) have raw water drain plugs and cleanout covers. If the engine keeps shutting down (Code No.1), have a qualified service person clean the raw water tubes.

Drain the heat exchanger if there is a danger of freezing when the generator set is not running or is in storage. (Freezing water can damage the raw water tubes in the heat exchanger. Engine coolant, but not raw water, is protected from freezing.)

CAUTION *Models MDKBT and MDKBU—Do not overtighten the heat exchanger mounting straps or the heat exchanger could be deformed. Torque the strap screws as specified in Figure 4-6.*

Zinc Anode

Replace the zinc anode as recommended (Table 4-1). Use thread sealant on the zinc plug and drain plugs and replace the clean out cover gaskets if the old ones are torn or otherwise damaged.

Siphon Break

See Table 4-1 for scheduled maintenance. A siphon break is installed when the exhaust-water mixer is below the water line. If of a spring-loaded valve design, check for free movement of the plunger. Replace the device if the plunger does not move freely or the body is encrusted with deposits from leakage past the valve seat. If of the bleed-vent type, check that the vent hose is properly connected on both ends. If the vent is connected to a through-hull fitting, check for normal water flow whenever the engine is running. See the Installation Manual for more information regarding siphon break installation.

WARNING *Bypassing a siphon break or failing to maintain it can lead to engine flooding and damage to the engine not covered under Warranty.*

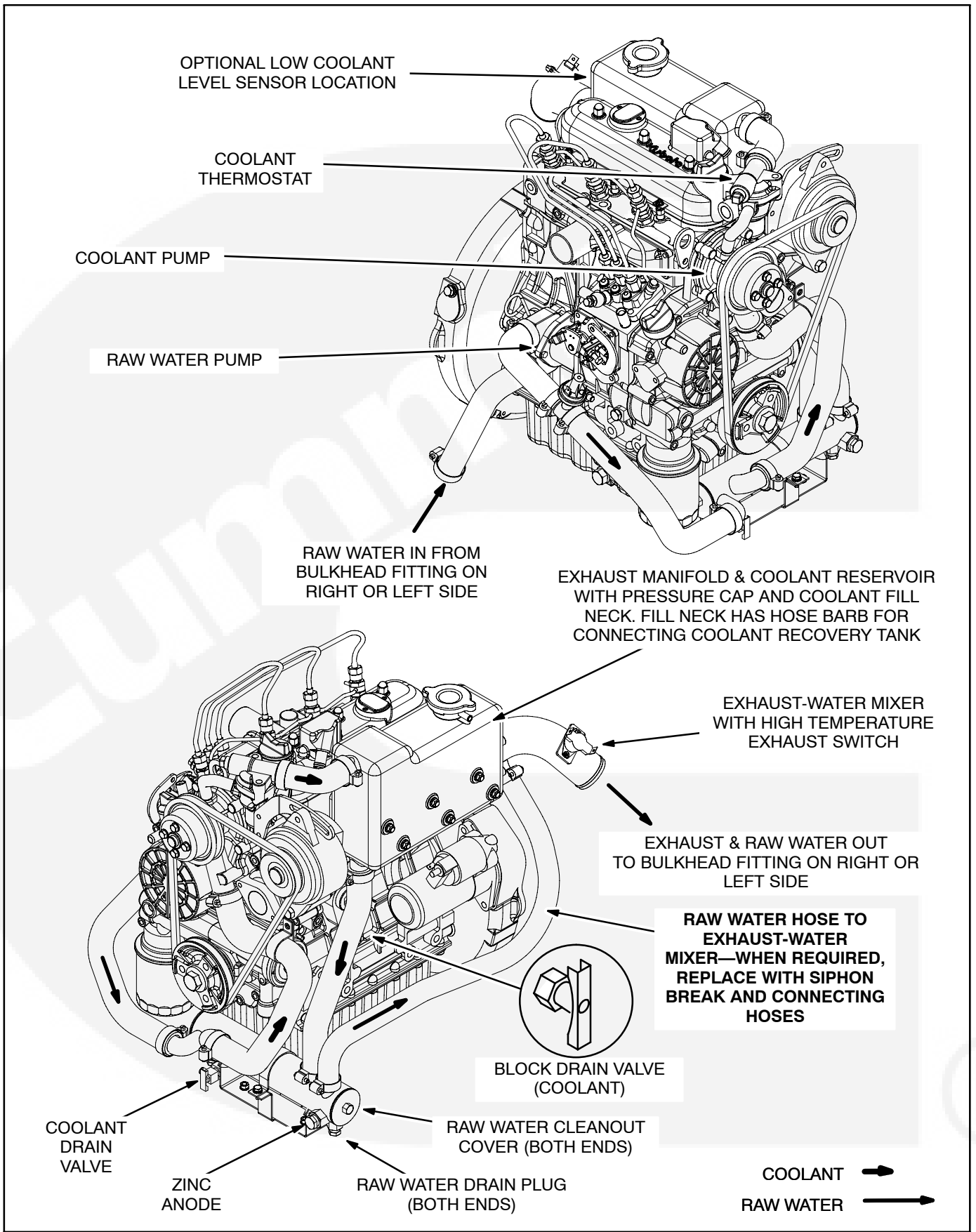

FIGURE 4-4. ENGINE COOLING SYSTEM—MDK BK, MDK BL, MDK BM, MDK BN

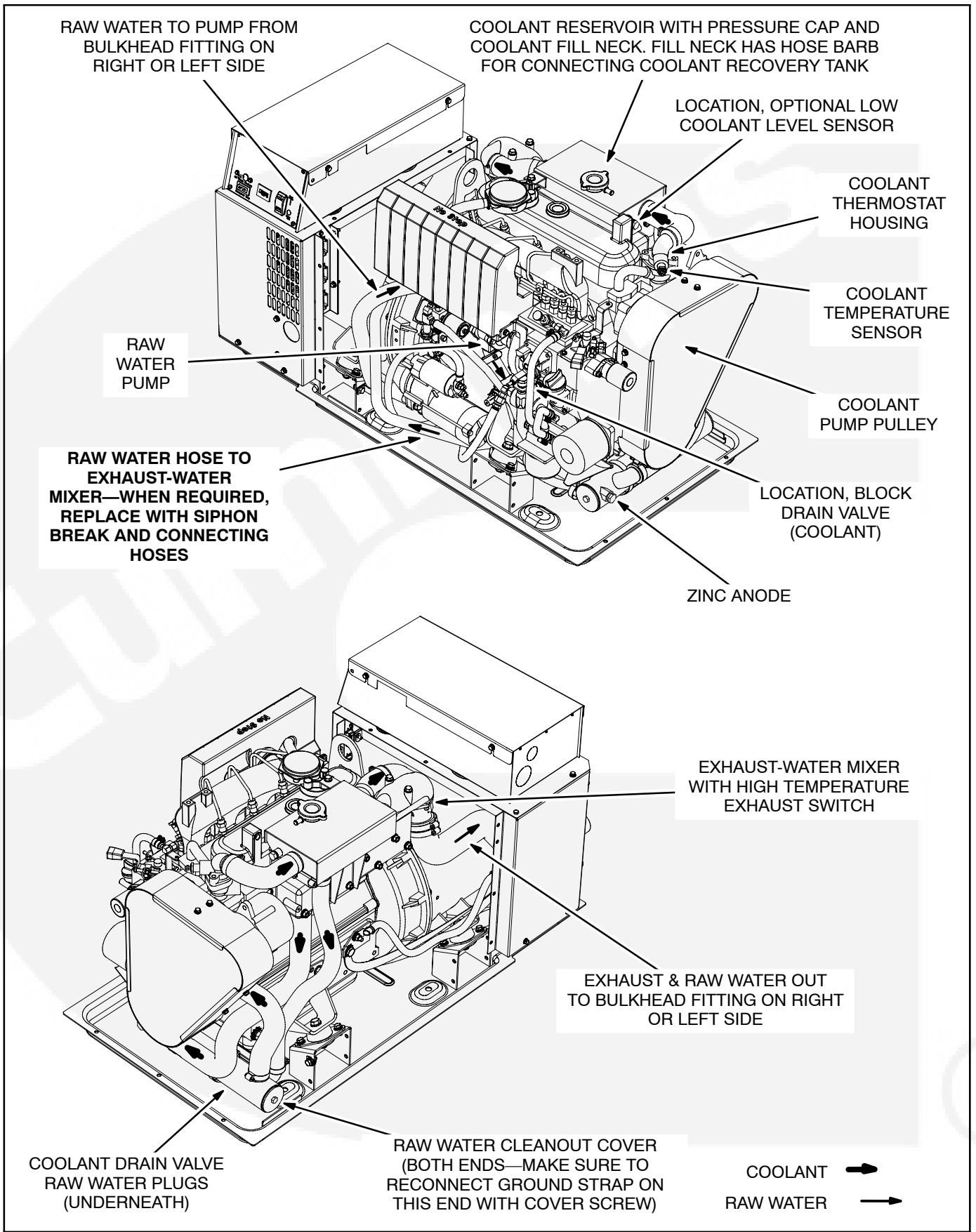

FIGURE 4-5. ENGINE COOLING SYSTEM—MDKBP, MDKBR, MDKBV

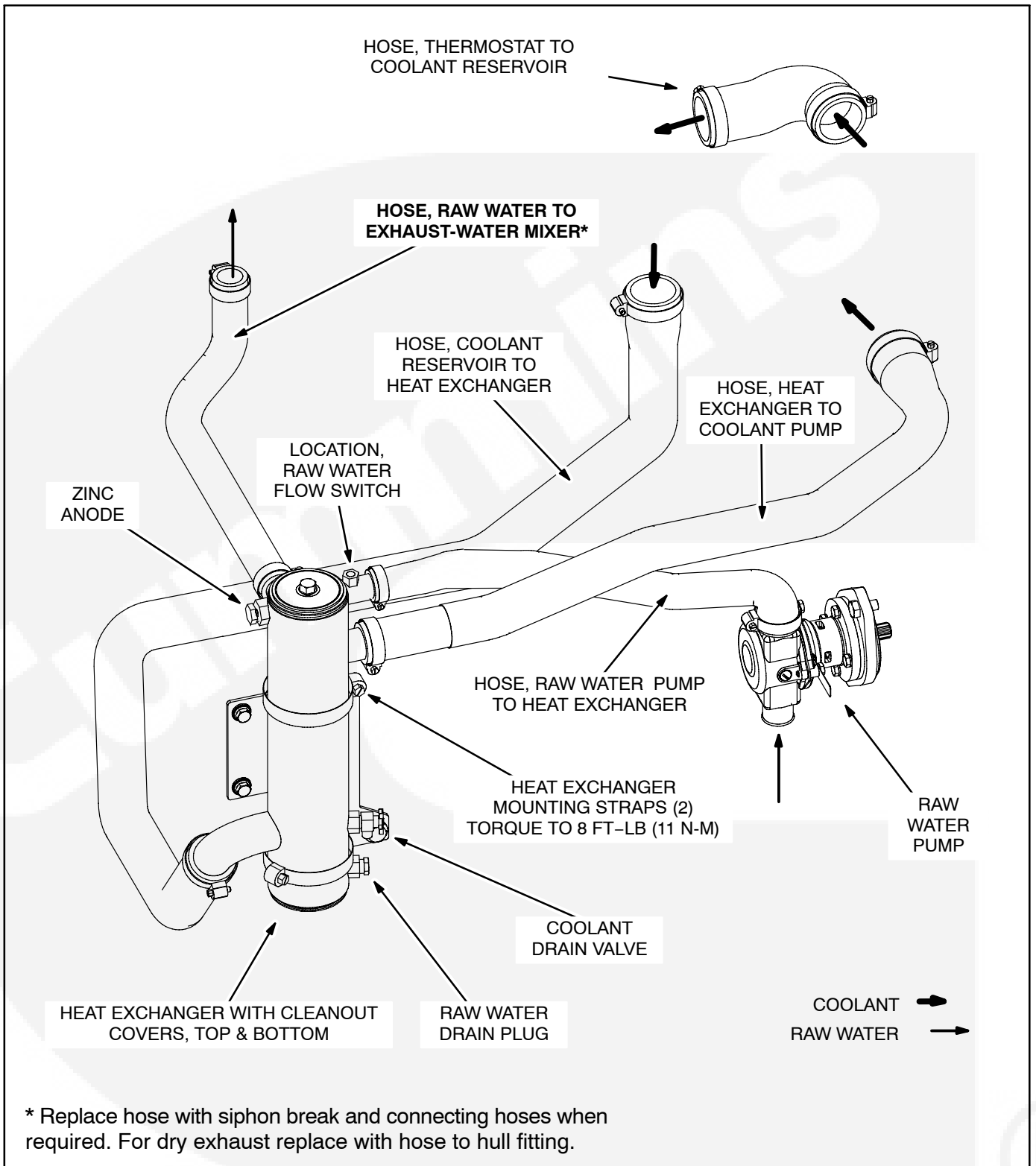
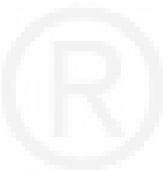

FIGURE 4-6. ENGINE COOLING SYSTEM HOSES, HEAT EXCHANGER, RAW WATER PUMP—MDKBT, MDKBU



5. Troubleshooting

Use TABLE 5-1. TROUBLESHOOTING GENERATOR SET FAULTS in conjunction with the Digital Display or blinking control switch status lamp to troubleshoot the generator set. Perform the step-by-step corrective actions suggested. If you are still unable to resolve the problem, contact an authorized Cummins Onan service representative. See *How to Obtain Service* (p. 1-2).

Note: Many generator set shutdowns can be avoided by performing periodic maintenance on schedule (TABLE 4-1. PERIODIC MAINTENANCE SCHEDULE) and by *not* running the generator set out of fuel. Note that when generator sets and propulsion engines draw from the same fuel tanks, the fuel pickup tubes are usually arranged so that the generator sets run out of fuel first. By marking the generator set empty points on the fuel gauges, it will be easier to tell when to stop the generator sets before running them out of fuel.

Break-Out Tool 420-0624

Break-out tool 420-0624 for use in conjunction with an accurate digital multi-meter is available for performing stator winding output tests while running the generator set. The tool is plugged into the generator set wiring harness in place of the generator set control. Follow the tool instructions.

TROUBLESHOOTING WITH DIGITAL DISPLAY

If a fault shutdown occurs the ALARM status lamp on the Digital Display will blink and the LCD screen will display the Fault Number, a description of the Fault and the hour in total generator set running time when the Fault occurred (Figure 2-4).

The fault will be displayed until it is cleared. Touch any button to clear the fault. The display will turn off in 5 minutes after the fault has been cleared.

See Page 2-6 to display any of the last five faults in fault history.

TROUBLESHOOTING WITH STATUS LAMP

If a fault shutdown occurs, the amber status lamp on the control switch will repeatedly blink sets of 3, 4, 5 or 7 blinks.

- **One blink** indicates shutdown due to high engine temperature.
- **Two blinks** indicate shutdown due to low oil pressure.
- **Three blinks** indicate a service fault. Press **Stop** once to cause the two-digit shutdown code to blink. (Pressing **Stop** again will stop the blinking.) The two-digit code consists of 1 to 7 blinks, a brief pause, and then 1 to 9 blinks. The first set of blinks represents the tens digit and the second set of blinks the units digit of the shutdown code number. For example, **Low Voltage Code No. 13** appears as: **blink—pause—blink-blink-blink—long pause—repeat**
- **Four blinks** indicate shutdown due to a failure to start within the time allowed for cranking.
- **Five blinks** indicate shutdown due to high levels of Carbon Monoxide (CO) in the vessel.
- **Seven blinks** indicate shutdown due to a loss of raw water flow for engine and exhaust cooling.

Blinking continues for five minutes and stops. To restore blinking press the control switch to **STOP (Prime)** until the lamp comes on (3 to 4 seconds). Then press **STOP (Prime)** three times to restore blinking.

Note: The last fault logged will blink even though the condition that caused the shutdown may have been corrected.

TABLE 5-1. TROUBLESHOOTING GENERATOR SET FAULTS

⚠WARNING *Some generator set service procedures present hazards that can result in severe personal injury or death. Only trained and experienced service personnel with knowledge of fuels, electricity, and machinery hazards should perform generator set service. See Safety Precautions.*

Accidental or remote starting can cause severe personal injury or death. Before removing a panel or access door, disconnect the negative (-) cable from the battery to prevent the engine from starting.

NO RESPONSE AT DIGITAL DISPLAY OR CONTROL SWITCH

(Faulty switch, poor or missing connections, dead battery)

Corrective Action:

1. Push the Emergency Stop and/or DC Circuit Breaker **ON** if tripped.
2. Try the Digital Display or control switch on the generator set (local) if there is no response at a remote Display or control switch, and vice versa..
3. If none of the Displays or control switches works, service as necessary by cleaning and tightening battery connections, recharging or replacing the battery or replacing damaged battery cables (p. 4-2).

THE STARTER ENGAGES AND DISENGAGES

(Low cranking voltage)

Corrective Action:

1. De-energize the PTO clutch, if so equipped.
2. Service as necessary by cleaning and tightening battery connections, recharging or replacing the battery or replacing damaged battery cables (p. 4-2).

THE STARTING BATTERIES DO NOT MAINTAIN A CHARGE

(Marginal battery, battery connections or charging system)

Corrective Action:

1. Service as necessary by cleaning and tightening battery connections, recharging or replacing the battery or replacing damaged battery cables (p. 4-2).
2. Check for and disconnect parasitic battery loads.

NO AC POWER WHEN GENERATOR SET IS RUNNING

(A Circuit Breaker is OFF, tripped or malfunctioning or the generator is not connected properly)

Corrective Action:

1. Reset, turn ON or repair the generator set circuit breaker, as necessary.
2. Reset, turn ON or repair any other circuit breaker in the AC power supply system, as necessary.

TABLE 5-1. TROUBLESHOOTING GENERATOR SET FAULTS (CONT.)

⚠WARNING *Some generator set service procedures present hazards that can result in severe personal injury or death. Only trained and experienced service personnel with knowledge of fuels, electricity, and machinery hazards should perform generator set service. See Safety Precautions.*

Accidental or remote starting can cause severe personal injury or death. Before removing a panel or access door, disconnect the negative (-) cable from the battery to prevent the engine from starting.

HIGH ENGINE TEMPERATURE—CODE NO. 1

(Engine coolant temperature exceeds design limit)

Corrective Action:

1. Check for and clean a blocked sea water strainer. If above the water line, fill the strainer with water to assist priming.
2. Check engine coolant level and add coolant as necessary.
3. Check for kinked or leaking hoses and reconnect, reroute or replace.
4. Inspect the siphon break for proper operation (p. 4-8).
5. Check for a worn raw water impeller and replace as necessary (p. 4-12).
6. Clean the heat exchanger (p. 4-8).
7. Check the bottom of the hull for any blockage at the through-hull fitting.
8. Drain and clean the coolant system to remove coolant passage fouling (Page 4-7).

LOW OIL PRESSURE—CODE NO. 2

(Low oil pressure)

Corrective Action: Check the engine oil level and add or drain oil as necessary (p. 4-3). Repair any oil leaks.

SERVICE CHECK—CODE NO. 3

(A fault with a 2-Digit Fault Code Number occurred)

Corrective Action: Check the 2-Digit fault code by *Pushing* and *Releasing Stop*. The 2-Digit fault will be one of the following in this table. (Does not apply to Digital Display.)

OVERCRANK—CODE NO. 4

(Cranking time exceeded 20 to 60 seconds, depending on engine temperature)

Corrective Action:

1. De-energize the PTO clutch, if so equipped.
2. Check fuel level and refill as necessary. (Note: The generator set fuel pickups are probably higher than the propulsion engine fuel pickups.)
3. Open any closed fuel supply and return valves.
4. Prime the engine fuel system for at least 30 seconds (p. 3-3).
5. Service as necessary by cleaning and tightening battery connections, recharging or replacing the battery or replacing damaged battery cables (p. 4-2).
6. Remove combustion air or exhaust system blockages.
7. Check all fuel fittings for fuel and air leaks and tighten as necessary.
8. Replace fuel filters (p. 4-6).
9. Check for contaminated fuel by connecting to a source of known fuel quality.
10. Change the engine oil to oil of the proper viscosity for the ambient temperature. High oil viscosity can slow down cranking speed.

TABLE 5-1. TROUBLESHOOTING GENERATOR SET FAULTS (CONT.)

▲WARNING *Some generator set service procedures present hazards that can result in severe personal injury or death. Only trained and experienced service personnel with knowledge of fuels, electricity, and machinery hazards should perform generator set service. See Safety Precautions.*

Accidental or remote starting can cause severe personal injury or death. Before removing a panel or access door, disconnect the negative (-) cable from the battery to prevent the engine from starting.

WARNING—SHUTDOWN DUE TO VESSEL CO—CODE NO. 5

(Dangerous levels of Carbon Monoxide in Vessel)

Corrective Action: Get everyone out into fresh air immediately and seek medical attention.

LOSS OF RAW WATER FLOW—CODE NO. 7

(Low raw water pressure in heat exchanger)

Corrective Action:

1. Open the sea cock.
2. Check for a blocked sea water strainer and clean it out. If above the water line, fill the strainer with water to assist priming.
3. Check for kinked or leaking hoses and reconnect, reroute or replace.
4. Check for a worn raw water impeller and replace as necessary (p. 4-12).
5. Check the bottom of the hull for any blockage at the through-hull fitting.

HIGH AC VOLTAGE—CODE NO. 12

(After voltage regulation was enabled Output Voltage jumped to more than 125% of rated for 75 milliseconds or to more than 115% of rated for 3 seconds)

Corrective Action:

1. Check for a tripped generator set circuit breaker, reset if necessary, and run with fewer loads. (A breaker tripping under load can cause generator set voltage to overshoot.)
2. Check all fuel fittings and filters for fuel and air leaks and tighten as necessary. (Air bubbles can disrupt generator set frequency/voltage.)
3. Prime the engine fuel system for at least 30 seconds (p. 3-3).

LOW AC VOLTAGE—CODE NO. 13

(After voltage regulation was enabled Output Voltage fell to less than 90% of rated for 5 seconds)

Corrective Action:

1. Push the generator set line circuit breaker OFF and disconnect the PTO, if so equipped. If the generator set now runs and voltage and frequency are normal, reduce the number of electrical and mechanical (PTO) loads.
2. Check the fuel tank and fill as necessary. (Note: The arrangement of pickup tubes in the fuel supply tank probably is such that the generator set will run out of fuel before the propulsion engines.)
3. Check all fuel fittings and filters for fuel and air leaks and tighten as necessary. (Air bubbles can disrupt generator set frequency/voltage.)
4. Replace fuel filters (p. 4-6).

TABLE 5-1. TROUBLESHOOTING GENERATOR SET FAULTS (CONT.)

⚠WARNING *Some generator set service procedures present hazards that can result in severe personal injury or death. Only trained and experienced service personnel with knowledge of fuels, electricity, and machinery hazards should perform generator set service. See Safety Precautions.*

Accidental or remote starting can cause severe personal injury or death. Before removing a panel or access door, disconnect the negative (-) cable from the battery to prevent the engine from starting.

HIGH AC FREQUENCY—CODE NO. 14

(After the starter was engaged Frequency jumped to more than 70 Hz for 40 milliseconds or to more than 2% over nominal for 6 seconds)

Corrective Action:

1. Check for a tripped generator set circuit breaker, reset if necessary, and run with fewer loads. (A breaker tripping under load can cause generator set frequency to overshoot.)
2. Check all fuel fittings and filters for fuel and air leaks and tighten as necessary. (Air bubbles can disrupt frequency.)

LOW AC FREQUENCY—CODE NO. 15

(During normal operation Frequency fell to less than 90% of nominal for more than 8 seconds)

Corrective Action:

1. Push the generator set line circuit breaker OFF and de-energize the PTO clutch, if so equipped. If the generator set now runs, reduce the number of electrical and mechanical (PTO) loads, especially those with high motor starting loads, such as air conditioners.
2. Check the fuel tank and fill as necessary. (Note: The arrangement of pickup tubes in the fuel supply tank probably is such that the generator set will run out of fuel before the propulsion engines.)
3. Prime the engine fuel system for at least 30 seconds (p. 3-3).
4. Remove combustion air or exhaust system blockages.
5. Check all fuel fittings for fuel and air leaks and tighten as necessary. (Air bubbles can disrupt frequency.)
6. Replace fuel filters (p. 4-6).
7. Check for contaminated fuel by connecting to a source of known fuel quality.

GOVERNOR OVERLOAD—CODE NO. 22

(Maximum allowable time at full-duty cycle was exceeded)

Corrective Action:

1. Reduce the number of appliances running at the same time, especially those with high motor starting loads such as air conditioners.
2. Check the fuel tank and fill as necessary. (Note: The arrangement of pickup tubes in the fuel supply tank probably is such that the generator set will run out of fuel before the propulsion engines.)
3. Remove combustion air or exhaust system blockages.
4. Check all fuel fittings for fuel and air leaks and tighten as necessary.
5. Replace fuel filters (p. 4-6).
6. Check for contaminated fuel by connecting to a source of known fuel quality.

FAULTY OIL PRESSURE SENDER—CODE NO. 23

(Controller sensed grounded sender)

Corrective Action: See an authorized Cummins Onan service representative.

TABLE 5-1. TROUBLESHOOTING GENERATOR SET FAULTS (CONT.)

⚠WARNING *Some generator set service procedures present hazards that can result in severe personal injury or death. Only trained and experienced service personnel with knowledge of fuels, electricity, and machinery hazards should perform generator set service. See Safety Precautions.*

Accidental or remote starting can cause severe personal injury or death. Before removing a panel or access door, disconnect the negative (-) cable from the battery to prevent the engine from starting.

FAULTY TEMPERATURE SENDER—CODE NO. 24

(Controller sensed open sender)

Corrective Action: See an authorized Cummins Onan service representative.

LOSS OF AC VOLTAGE SENSE—CODE NO. 27

(The generator set Controller lost VAC sensing during normal voltage regulation when the field was functioning normally and frequency was at least 40 Hz)

Corrective Action: See an authorized Cummins Onan service representative.

HIGH BATTERY VOLTAGE—CODE NO. 29

(During startup the generator set Controller sensed that battery system voltage was greater than 19.2 volts if 12 VDC system or 32.2 volts if 24 volt system)

Corrective Action:

1. Check battery bank connections and reconnect if necessary for 12 volts or 24 volts, depending on generator set model.
2. Select a lower battery booster charge rate (external charging system).

STARTING FAULT—CODE NO. 32

(The generator set Controller could not detect cranking speed [quadrature zero crossings] for 3 seconds)

Corrective Action:

1. De-energize the PTO clutch, if so equipped.
2. Have the propulsion engines running while trying to start the generator set. Their charging alternators may be able to maintain a high enough battery terminal voltage to start the generator set.
3. Service as necessary by cleaning and tightening battery connections, recharging or replacing the battery or replacing damaged battery cables (p. 4-2).
4. Change the engine oil to oil of the proper viscosity for the ambient temperature. High oil viscosity can slow down cranking speed.

CONTROL CARD FAILURE-EE—CODE NO. 35

(During startup the generator set Controller detected a EE memory error)

Corrective Action: See an authorized Cummins Onan service representative.

TABLE 5-1. TROUBLESHOOTING GENERATOR SET FAULTS (CONT.)

⚠WARNING *Some generator set service procedures present hazards that can result in severe personal injury or death. Only trained and experienced service personnel with knowledge of fuels, electricity, and machinery hazards should perform generator set service. See Safety Precautions.*

Accidental or remote starting can cause severe personal injury or death. Before removing a panel or access door, disconnect the negative (-) cable from the battery to prevent the engine from starting.

UNKNOWN SHUTDOWN—CODE NO. 36

(The generator set Controller declared this fault because engine speed fell below 1000 RPM for 0.5 seconds, though not by generator set or engine control action)

Corrective Action:

1. Check for mechanical damage and service as necessary.
2. Push the generator set line circuit breaker OFF and disconnect the PTO, if so equipped. If the generator set now runs, reduce the number of electrical and mechanical (PTO) loads.
3. Check fuel level and refill as necessary. (Note: The generator set fuel pickups are probably higher than the propulsion engine fuel pickups.)
4. Prime the engine fuel system for at least 30 seconds (p. 3-3).
5. Remove combustion air or exhaust system blockages.
6. Check all fuel fittings for fuel and air leaks and tighten as necessary.
7. Replace fuel filters (p. 4-6).

INVALID GENERATOR SET CONFIGURATION—CODE NO. 37

(The generator set Controller is not configured properly for the generator set)

Corrective Action: See an authorized Cummins Onan service representative.

FIELD OVERLOAD—CODE NO. 38

(High field voltage induced by high rotor temperature or low power factor loads)

Corrective Action:

1. Remove blockages to generator air flow at the front inlet air grill.
2. Reduce the number of appliances running at the same time, especially those with high motor starting loads, such as air conditioners.
3. Have air conditioners and other appliances checked for proper operation. (A locked compressor rotor can cause very low power factor.)

CONTROL CARD FAILURE—RAM—CODE NO. 43

(During startup the generator set Controller detected a RAM memory error)

Corrective Action: See an authorized Cummins Onan service representative.

SPEED SENSE LOST—CODE NO. 45

(After start disconnect the generator set Controller lost speed sense [quadrature zero crossings] for 0.25 seconds)

Corrective Action: See an authorized Cummins Onan service representative.

TABLE 5-1. TROUBLESHOOTING GENERATOR SET FAULTS (CONT.)

⚠WARNING *Some generator set service procedures present hazards that can result in severe personal injury or death. Only trained and experienced service personnel with knowledge of fuels, electricity, and machinery hazards should perform generator set service. See Safety Precautions.*

Accidental or remote starting can cause severe personal injury or death. Before removing a panel or access door, disconnect the negative (-) cable from the battery to prevent the engine from starting.

OVERPRIME—CODE NO. 57

(A local or remote control switch was held in the Prime position for more than 5 minutes)

Corrective Action: Check for and remove any object that may be holding any control switch (local or remote) in the prime position.

HIGH EXHAUST TEMPERATURE—CODE NO. 58

(Exhaust temperature exceeded design limits due to lack of water delivered to the exhaust/water mixer)

Corrective Action:

1. Check for and clean a blocked sea water strainer. If above the water line, fill the strainer with water to assist priming.
2. Inspect the siphon break (if provided) for proper operation.
3. Check for a worn raw water impeller and replace as necessary (p. 4-12).
4. Clean the heat exchanger (p. 4-8).

LOW COOLANT LEVEL—CODE NO. 59

(The engine coolant level fell below the optional coolant level sensor)

Corrective Action: Add coolant as necessary and repair leaks.

EXTERNAL SHUTDOWN—CODE NO. 61

(The generator set was shut down by a fire suppression system or other external control)

Corrective Action: Make all necessary repairs to the generator set and connected equipment and re-set the external control which shut down the generator set.



If you are still unable to resolve the problem, contact an authorized Cummins Onan service representative. See *How to Obtain Service* (p. 1-2).



6. Specifications

		MDK BK	MDK BL	MDK BM	MDK BN
ALTERNATOR: Single-Bearing, Brushless 4-Pole Rotating Field with Digital Electronic Regulation. See Generator Set Nameplate for Rating.					
FUEL CONSUMPTION:					
60 Hz:	Full Load Half Load	1.0 Gal/hr (3.8 L/hr) 0.5 Gal/hr (1.9 L/hr)	1.0 Gal/hr (3.8 L/hr) 0.5 Gal/hr (1.9 L/hr)	1.0 Gal/hr (3.9 L/hr) 0.7 Gal/hr (2.5 L/hr)	1.2 Gal/hr (4.5 L/hr) 0.7 Gal/hr (2.6 L/hr)
50 Hz:	Full Load Half Load	0.8 Gal/hr (2.8 L/hr) 0.4 Gal/hr (1.5 L/hr)	0.8 Gal/hr (2.8 L/hr) 0.4 Gal/hr (1.5 L/hr)	0.9 Gal/hr (3.4 L/hr) 0.6 Gal/hr (2.1 L/hr)	1.0 Gal/hr (4.0 L/hr) 0.6 Gal/hr (2.2 L/hr)
ENGINE: Kubota 4-Stroke Cycle, Indirect Injection, Water Cooled Diesel with Digital Electronic Governing					
Model		D1105	D1105	V1505	V1505
Number of Cylinders		3	3	4	4
Displacement		68.58 in ³ (1123 cm ³)	68.58 in ³ (1123 cm ³)	91.41 in ³ (1498 cm ³)	91.41 in ³ (1498 cm ³)
Bore		3.07 in (78 mm)	3.07 in (78 mm)	3.07 in (78 mm)	3.07 in (78 mm)
Stroke		3.09 in (78.4 mm)	3.09 in (78.4 mm)	3.09 in (78.4 mm)	3.09 in (78.4 mm)
Compression Ratio		24:1	24:1	24:1	24:1
Firing Order (Clockwise Rotation)		1-2-3	1-2-3	1-2-4-3	1-2-4-3
Fuel Injection Timing		14.75–16.25° BTDC	14.75–16.25° BTDC	14.25–15.75° BTDC	14.25–15.75° BTDC
Valve Lash (cold)		0.0071 – 0.0087 in (0.18 – 0.22 mm)	0.0071 – 0.0087 in (0.18 – 0.22 mm)	0.0071 – 0.0087 in (0.18 – 0.22 mm)	0.0071 – 0.0087 in (0.18 – 0.22 mm)
Lube Oil Capacity		4.2 quart (4.0 L)	4.2 quart (4.0 L)	4.5 quart (4.3 L)	4.5 quart (4.3 L)
Lube Oil Drain Connection		3/8 NPT	3/8 NPT	3/8 NPT	3/8 NPT
Coolant Capacity		4.2 quart (4.0 L)	4.2 quart (4.0 L)	5.3 quart (5.0 L)	5.3 quart (5.0 L)
Coolant Flow Rate:	60 Hz 50 Hz	5.0 Gal/min (18.9 L/min) 4.2 Gal/min (15.9 L/min)	5.0 Gal/min (18.9 L/min) 4.2 Gal/min (15.9 L/min)	5.0 Gal/min (18.9 L/min) 4.2 Gal/min (15.9 L/min)	5.0 Gal/min (18.9 L/min) 4.2 Gal/min (15.9 L/min)
Raw Water Flow Rate:	60 Hz 50 Hz	6.0 Gal/min (22.7 L/min) 5.0 Gal/min (18.9 L/min)	6.0 Gal/min (22.7 L/min) 5.0 Gal/min (18.9 L/min)	6.0 Gal/min (22.7 L/min) 5.0 Gal/min (18.9 L/min)	6.0 Gal/min (22.7 L/min) 5.0 Gal/min (18.9 L/min)
Combustion Air Flow:	60 Hz 50 Hz	30 ft ³ /min (0.85 m ³ /min) 25 ft ³ /min (0.71 m ³ /min)	30 ft ³ /min (0.85 m ³ /min) 25 ft ³ /min (0.71 m ³ /min)	41 ft ³ /min (1.16 m ³ /min) 34 ft ³ /min (0.95 m ³ /min)	41 ft ³ /min (1.16 m ³ /min) 34 ft ³ /min (0.96 m ³ /min)
Heat Rejection to Ambient:	60 Hz 50 Hz	200 Btu/min (50 kcal/min) 179 Btu/min (45 kcal/min)	200 Btu/min (50 kcal/min) 179 Btu/min (45 kcal/min)	280 Btu/min (71 kcal/min) 210 Btu/min (53 kcal/min)	280 Btu/min (71 kcal/min) 210 Btu/min (53 kcal/min)
Maximum Angularity		10° Continuous, 22.5° Intermittent			
Recommended Fuel		No. 2-D Diesel Fuel: Spec EN 590 or ASTM D975			
Recommended Coolant		Ethylene Glycol: Spec ASTM D5345 for 50/50 Prediluted Coolant or ASTM D4985 for Concentrated Coolant with 40% to 60% quality water			
CONNECTIONS:					
Max Fuel Pump Lift		4 ft (1.2 m)	4 ft (1.2 m)	4 ft (1.2 m)	4 ft (1.2 m)
Fuel Supply		1/4 NPT female	1/4 NPT female	1/4 NPT female	1/4 NPT female
Fuel Return		1/4 NPT female	1/4 NPT female	1/4 NPT female	1/4 NPT female
Max Raw Water Pump Lift		4 ft (1.22 m)	4 ft (1.22 m)	4 ft (1.22 m)	4 ft (1.22 m)
Raw Water Inlet		1 in (25.4 mm) ID Hose	1 in (25.4 mm) ID Hose	1 in (25.4 mm) ID Hose	1 in (25.4 mm) ID Hose
Wet Exhaust Outlet		2 in (50.8 mm) ID Hose	2 in (50.8 mm) ID Hose	2 in (50.8 mm) ID Hose	2 in (50.8 mm) ID Hose
Dry Exhaust Outlet		1-1/4 NPT	1-1/4 NPT	1-1/4 NPT	1-1/4 NPT
Max Exhaust Back Pressure		3 in (76 mm) Hg	3 in (76 mm) Hg	3 in (76 mm) Hg	3 in (76 mm) Hg
KEEL COOLING:					
Coolant Inlet & Outlet		1 in (25.4 mm) ID Hose	1 in (25.4 mm) ID Hose	1 in (25.4 mm) ID Hose	1 in (25.4 mm) ID Hose
Max Coolant Friction Head		1 psi (6.9 kPa)	1 psi (6.9 kPa)	1 psi (6.9 kPa)	1 psi (6.9 kPa)
Heat Rejection to Coolant:	60 Hz 50 Hz	950 Btu/min (239 kcal/min) 780 Btu/min (197 kcal/min)	950 Btu/min (239 kcal/min) 780 Btu/min (197 kcal/min)	1420 Btu/min (358 kcal/min) 1160 Btu/min (292 kcal/min)	1420 Btu/min (358 kcal/min) 1160 Btu/min (292 kcal/min)
Thermostat Opening Temperature		185° F (85° C)	185° F (85° C)	185° F (85° C)	185° F (85° C)
BATTERIES:					
Nominal Battery Voltage		12 volts (24 volts optional)	12 volts (24 volts optional)	12 volts (24 volts optional)	12 volts (24 volts optional)
Min CCA Rating – SAE @ 32° F (0° C)		360 amps	360 amps	500 amps	500 amps
Battery Charging @ 12/24 VDC		5/10 amps	5/10 amps	5/10 amps	5/10 amps
SIZE, WEIGHT, NOISE:					
Without Enclosure Dry Weight Dimensions: L x W x H		525 lbs (238 kg) 32.4 x 18.9 x 22.1 in (823 x 479 x 560 mm)	555 lbs (252 kg) 35.9 x 22.3 x 23.0 in (911 x 566 x 585 mm)	640 lbs (290 kg) 40.7 x 22.3 x 23.0 in (1033 x 566 x 585 mm)	640 lbs (290 kg) 40.7 x 22.3 x 23.0 in (1033 x 566 x 585 mm)
With Enclosure Noise Dry Weight Dimensions: L x W x H		–	66/65 dB(A) @ 60/50HZ 600 lbs (272 kg) 35.9 x 22.3 x 23.4 in (911 x 566 x 593 mm)	66/65 dB(A) @ 60/50HZ 695 lbs (315 kg) 40.7 x 22.3 x 23.4 in (1033 x 566 x 593 mm)	66/65 dB(A) @ 60/50HZ 695 lbs (315 kg) 40.7 x 22.3 x 23.4 in (1033 x 566 x 593 mm)

		MDKBP	MDKBR	MDKBV
ALTERNATOR: Single-Bearing, Brushless 4-Pole Rotating Field with Digital Electronic Regulation. See Generator Set Nameplate for Rating.				
FUEL CONSUMPTION:				
60 Hz:	Full Load	1.6 Gal/hr (6.0 L/hr)	1.9 Gal/hr (7.3 L/hr)	2.0 Gal/hr (7.4 L/hr)
	Half Load	0.9 Gal/hr (3.3 L/hr)	1.0 Gal/hr (4.0 L/hr)	1.2 Gal/hr (4.4 L/hr)
50 Hz:	Full Load	1.3 Gal/hr (4.8 L/hr)	1.7 Gal/hr (6.5 L/hr)	1.7 Gal/hr (6.6 L/hr)
	Half Load	0.7 Gal/hr (2.7 L/hr)	0.9 Gal/hr (3.4 L/hr)	1.0 Gal/hr (3.9 L/hr)
ENGINE: Kubota 4-Stroke Cycle, Indirect Injection, Water Cooled Diesel with Digital Electronic Governing				
Model		V2003m	V2403M	V2403M
Number of Cylinders		4	4	4
Displacement		122 in ³ (1999 cm ³)	149 in ³ (2434 cm ³)	149 in ³ (2434 cm ³)
Bore		3.27 in (83 mm)	3.43 in (87 mm)	3.43 in (87 mm)
Stroke		3.64 in (92.4 mm)	4.03 in (102.4 mm)	4.03 in (102.4 mm)
Compression Ratio		22.8:1	24.31	24.31
Firing Order (Clockwise Rotation)		1-3-4-2	1-3-4-2	1-3-4-2
Fuel Injection Timing		13.5–15° BTDC	13.5–15° BTDC	13.5–15° BTDC
Valve Lash (cold)		0.0071 – 0.0087 in (0.18 – 0.22 mm)	0.0071 – 0.0087 in (0.18 – 0.22 mm)	0.0071 – 0.0087 in (0.18 – 0.22 mm)
Lube Oil Capacity		8 quart (7.6 L)	8 quart (7.6 L)	8 quart (7.6 L)
Lube Oil Drain Connection		3/8 NPT	3/8 NPT	3/8 NPT
Coolant Capacity		8 quart (7.6 L)	8 quart (7.6 L)	8 quart (7.6 L)
Coolant Flow Rate:	60 Hz	14.0 Gal/min (53.0 L/min)	14.0 Gal/min (53.0 L/min)	14.0 Gal/min (53.0 L/min)
	50 Hz	10.0 Gal/min (37.9 L/min)	10.0 Gal/min (37.9 L/min)	10.0 Gal/min (37.9 L/min)
Raw Water Flow Rate:	60 Hz	9.0 Gal/min (34.1 L/min)	9.0 Gal/min (34.1 L/min)	9.0 Gal/min (34.1 L/min)
	50 Hz	7.0 Gal/min (26.5 L/min)	7.0 Gal/min (26.5 L/min)	7.0 Gal/min (26.5 L/min)
Combustion Air Flow:	60 Hz	52 ft ³ /min (1.45 m ³ /min)	60 ft ³ /min (1.72 m ³ /min)	60 ft ³ /min (1.72 m ³ /min)
	50 Hz	42 ft ³ /min (1.21 m ³ /min)	50 ft ³ /min (1.43 m ³ /min)	50 ft ³ /min (1.43 m ³ /min)
Heat Rejection to Ambient:	60 Hz	350 Btu/min (88 kcal/min)	420 Btu/min (106 kcal/min)	420 Btu/min (106 kcal/min)
	50 Hz	285 Btu/min (72 kcal/min)	350 Btu/min (88 kcal/min)	350 Btu/min (88 kcal/min)
Maximum Angularity		10° Continuous, 22.5° Intermittent		
Recommended Fuel		No. 2-D Diesel Fuel: Spec EN 590 or ASTM D975		
Recommended Coolant		Ethylene Glycol: Spec ASTM D5345 for 50/50 Prediluted Coolant or ASTM D4985 for Concentrated Coolant with 40% to 60% quality water		
CONNECTIONS:				
Max Fuel Pump Lift		4 ft (1.2 m)	4 ft (1.2 m)	4 ft (1.2 m)
Fuel Supply		1/4 NPT female	1/4 NPT female	1/4 NPT female
Fuel Return		1/4 NPT female	1/4 NPT female	1/4 NPT female
Max Raw Water Pump Lift		4 ft (1.22 m)	4 ft (1.22 m)	4 ft (1.22 m)
Raw Water Inlet		1 in (25.4 mm) ID Hose	1 in (25.4 mm) ID Hose	1 in (25.4 mm) ID Hose
Wet Exhaust Outlet		2 in (50.8 mm) ID Hose	2 in (50.8 mm) ID Hose	2 in (50.8 mm) ID Hose
Dry Exhaust Outlet		1-1/2 NPT	1-1/2 NPT	1-1/2 NPT
Max Exhaust Back Pressure		3 in (76 mm) Hg	3 in (76 mm) Hg	3 in (76 mm) Hg
KEEL COOLING:				
Coolant Inlet & Outlet		1 in (25.4 mm) ID Hose	1 in (25.4 mm) ID Hose	1 in (25.4 mm) ID Hose
Max Coolant Friction Head		1 psi (6.9 kPa)	1 psi (6.9 kPa)	1 psi (6.9 kPa)
Heat Rejection to Coolant:	60 Hz	1590 Btu/min (402 kcal/min)	1980 Btu/min (500 kcal/min)	1980 Btu/min (500 kcal/min)
	50 Hz	1500 Btu/min (379 kcal/min)	1670 Btu/min (422 kcal/min)	1670 Btu/min (422 kcal/min)
Thermostat Opening Temperature		185° F (85° C)	185° F (85° C)	185° F (85° C)
BATTERIES:				
Nominal Battery Voltage		12 volts (24 volts optional)	12 volts (24 volts optional)	12 volts (24 volts optional)
Min CCA Rating – SAE @ 32° F (0° C)		500 amps	625 amps	625 amps
Battery Charging @ 12/24 VDC		40/20 amps	40/20 amps	40/20 amps
SIZE, WEIGHT, NOISE:				
Without Enclosure Dry Weight Dimensions: L x W x H		830 lbs (377 kg) 44.4 x 23.7 x 26.1 in (1127 x 602 x 672 mm)	870 lbs (395 kg) 44.4 x 23.7 x 26.1 in (1127 x 602 x 672 mm)	870 lbs (395 kg) 44.4 x 23.7 x 26.1 in (1127 x 602 x 672 mm)
With Enclosure Noise Dry Weight Dimensions: L x W x H		67/64 dB(A) @ 60/50 HZ 890 lbs (404 kg) 44.4 x 23.7 x 27.5 in (1127 x 602 x 698 mm)	67/64 dB(A) @ 60/50 HZ 930 lbs (422 kg) 44.4 x 23.7 x 27.5 in (1127 x 602 x 698 mm)	67/64 dB(A) @ 60/50 HZ 930 lbs (422 kg) 44.4 x 23.7 x 27.5 in (1127 x 602 x 698 mm)

		MDKBT	MDKBU
ALTERNATOR: Single-Bearing, Brushless 4-Pole Rotating Field with Digital Electronic Regulation. See Generator Set Nameplate for Rating.			
FUEL CONSUMPTION:			
60 Hz:	Full Load Half Load	2.5 Gal/hr (9.5 L/hr) 1.5 Gal/hr (5.7 L/hr)	3.0 Gal/hr (11.2 L/hr) 1.5 Gal/hr (5.6 L/hr)
50 Hz:	Full Load Half Load	2.1 Gal/hr (8.0 L/hr) 1.5 Gal/hr (5.6 L/hr)	2.4 Gal/hr (9.1 L/hr) 1.5 Gal/hr (5.7 L/hr)
ENGINE: Kubota 4-Stroke Cycle, Indirect Injection, Water Cooled Diesel with Digital Electronic Governing			
Model		V3300-E2B	V3300-E2B
Number of Cylinders		4	4
Displacement		202.48 in ³ (3318 cm ³)	202.48 in ³ (3318 cm ³)
Bore		3.86 in (98 mm)	3.86 in (98 mm)
Stroke		4.33 in (110 mm)	4.33 in (110 mm)
Compression Ratio		22.5:1	22.5:1
Firing Order (Clockwise Rotation)		1-3-4-2	1-3-4-2
Fuel Injection Timing		12° BTDC	12° BTDC
Valve Lash (cold)		0.009 – 0.010 in (0.23 – 0.27 mm)	0.009 – 0.010 in (0.23 – 0.27 mm)
Lube Oil Capacity		11 quart (10.4 L)	11 quart (10.4 L)
Lube Oil Drain Connection		3/8 NPT	3/8 NPT
Coolant Capacity		14.5 quart (13.7 L)	14.5 quart (13.7 L)
Coolant Flow Rate:	60 Hz 50 Hz	14.0 Gal/min (53.0 L/min) 11.5 Gal/min (43.5 L/min)	14.0 Gal/min (53.0 L/min) 11.5 Gal/min (43.5 L/min)
Raw Water Flow Rate:	60 Hz 50 Hz	15.6 Gal/min (59.1 L/min) 13.0 Gal/min (49.2 L/min)	15.6 Gal/min (59.1 L/min) 13.0 Gal/min (49.2 L/min)
Combustion Air Flow:	60 Hz 50 Hz	91.7 ft ³ /min (2.6 m ³ /min) 76.5 ft ³ /min (2.2 m ³ /min)	91.7 ft ³ /min (2.6 m ³ /min) 76.5 ft ³ /min (2.2 m ³ /min)
Heat Rejection to Ambient:	60 Hz 50 Hz	532 Btu/min (134 kcal/min) 441 Btu/min (111 kcal/min)	629 Btu/min (159 kcal/min) 515 Btu/min (130 kcal/min)
Maximum Angularity		10° Continuous, 22.5° Intermittent	
Recommended Fuel		No. 2-D Diesel Fuel: Spec EN 590 or ASTM D975	
Recommended Coolant		Ethylene Glycol: Spec ASTM D5345 for 50/50 Prediluted Coolant or ASTM D4985 for Concentrated Coolant with 40% to 60% quality water	
CONNECTIONS:			
Max Fuel Pump Lift		4 ft (1.2 m)	4 ft (1.2 m)
Fuel Supply		1/4 NPT female	1/4 NPT female
Fuel Return		1/4 NPT female	1/4 NPT female
Max Raw Water Pump Lift		4 ft (1.22 m)	4 ft (1.22 m)
Raw Water Inlet		1.25 in (31.7 mm) ID Hose	1.25 in (31.7 mm) ID Hose
Wet Exhaust Outlet		3 in (76.2 mm) ID Hose	3 in (76.2 mm) ID Hose
Dry Exhaust Outlet		2 in NPT	2 in NPT
Max Exhaust Back Pressure		3 in (76 mm) Hg	3 in (76 mm) Hg
KEEL COOLING:			
Coolant Inlet & Outlet		1.25 in (31.7 mm) ID Hose	1.25 in (31.7 mm) ID Hose
Max Coolant Friction Head		1 psi (6.9 kPa)	1 psi (6.9 kPa)
Heat Rejection to Coolant:	60 Hz 50 Hz	2200 Btu/min (555 kcal/min) 1870 Btu/min (470 kcal/min)	2600 Btu/min (655 kcal/min) 2200 Btu/min (555 kcal/min)
Thermostat Opening Temperature		170° F (76.5° C)	170° F (76.5° C)
BATTERIES:			
Nominal Battery Voltage		12 volts (24 volts optional)	12 volts (24 volts optional)
Min CCA Rating – SAE @ 32° F (0° C)		625 amps	625 amps
Net Battery Charging (Negative Ground)		12 volts: 30.0/22.0 amps (60/50 Hz) 24 volts: 22.5/20.5 amps (60/50 Hz)	12 volts: 30.0/22.0 amps (60/50 Hz) 24 volts: 22.5/20.5 amps (60/50 Hz)
Net Battery Charging (Isolated Ground)		12 volts: 43.0/40.0 amps (60/50 Hz) 24 volts: 30.5/28.5 amps (60/50 Hz)	12 volts: 43.0/40.0 amps (60/50 Hz) 24 volts: 30.5/28.5 amps (60/50 Hz)
SIZE, WEIGHT, NOISE:			
Without Sound Shield Dry Weight Dimensions: L x W x H		1245 lbs (565 kg) 53.5 x 24.5 x 28.8 in (1358 x 622 x 731 mm)	1300 lbs (590 kg) 53.5 x 24.5 x 28.8 in (1358 x 622 x 731 mm)
With Sound Shield Noise Dry Weight Dimensions: L x W x H		68/67 dB(A) @ 60/50 HZ 1325 lbs (601 kg) 53.5 x 24.5 x 30.0 in (1358 x 622 x 761 mm)	68/67 dB(A) @ 60/50 HZ 1380 lbs (626 kg) 53.5 x 24.5 x 30.0 in (1358 x 622 x 761 mm)

7. Maintenance Record

Record all periodic and unscheduled maintenance and service. See *Periodic Maintenance* (Section 4).

DATE	HOUR METER READING	MAINTENANCE OR SERVICE PERFORMED

Record the name, address, and phone number of your authorized Cummins Onan service center.

Cummins Onan

Cummins Power Generation

1400 73rd Ave. NE
Minneapolis, MN 55432 USA

Phone 1 763 574 5000

Toll-free 1 800 888 6626

Fax 1 763 574 5298

Email www.cumminsonan.com/contact

www.cumminsonan.com

Cummins®, Onan®, the "C" logo, and "Performance you rely on." are trademarks of Cummins Inc.

©2010 Cummins Power Generation, Inc. All rights reserved.

